

news.09



H6-flat 05
m2 17
plus 43



H6-flat

design: david dolcini

flat, thin, modern.





72x90
75x100
75x110
80x120
80x140

H6

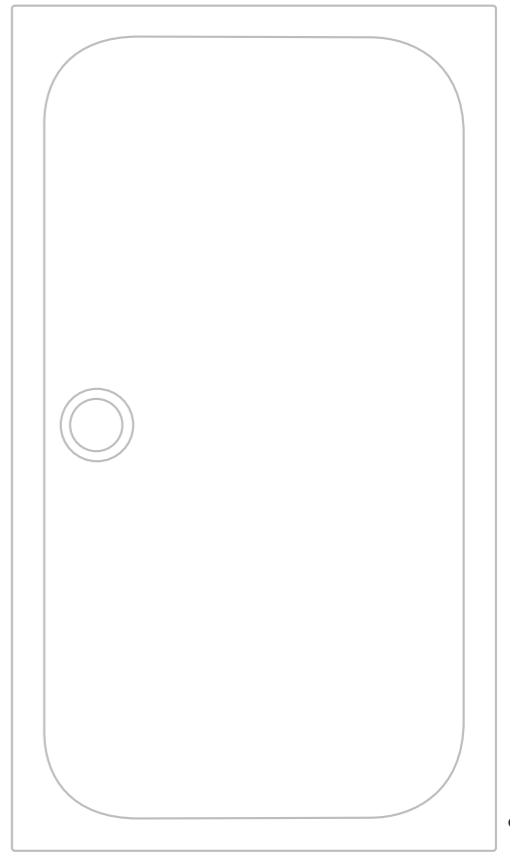









m2

design: romano adolini
ufficio tecnico





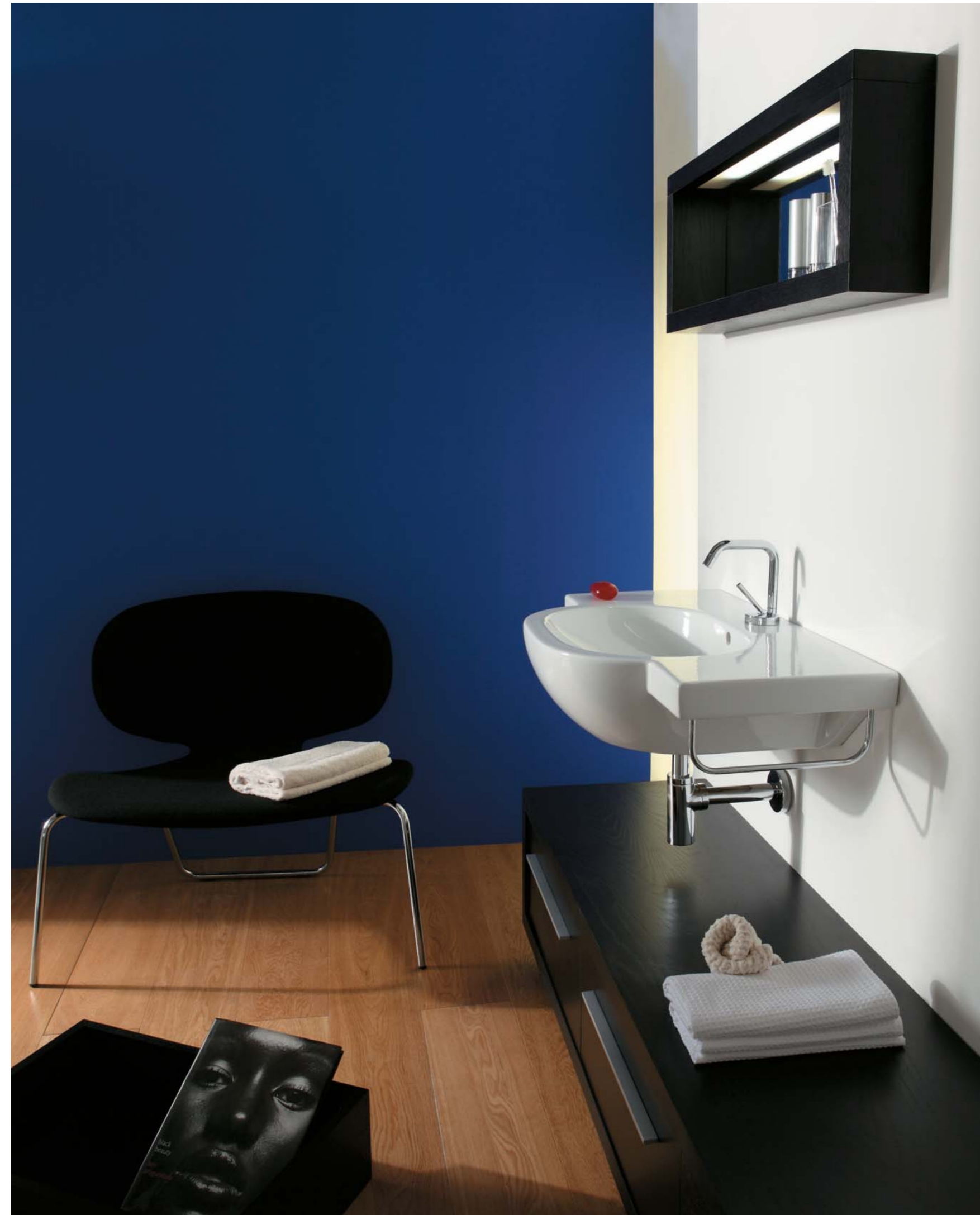





design for modern living



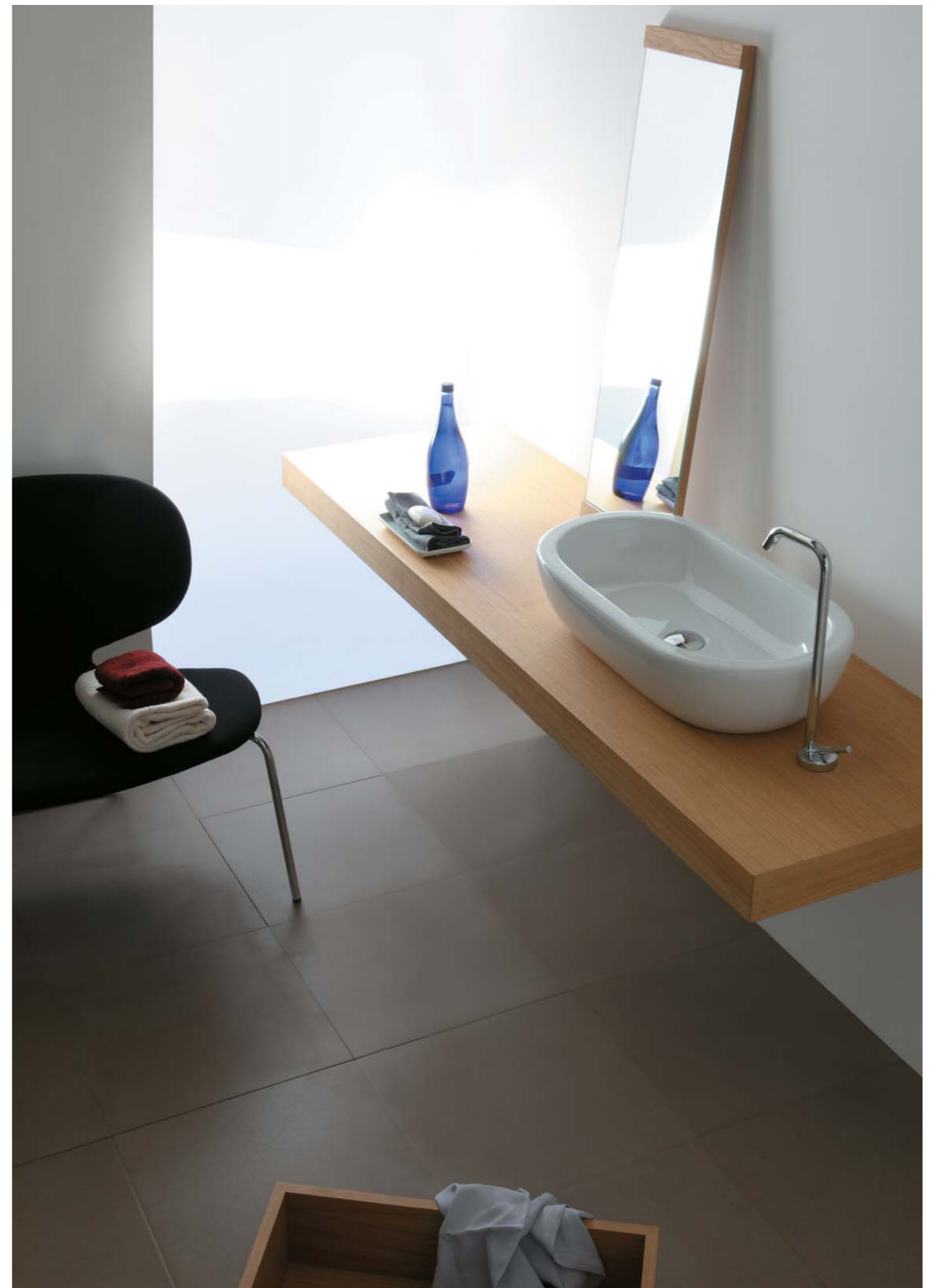



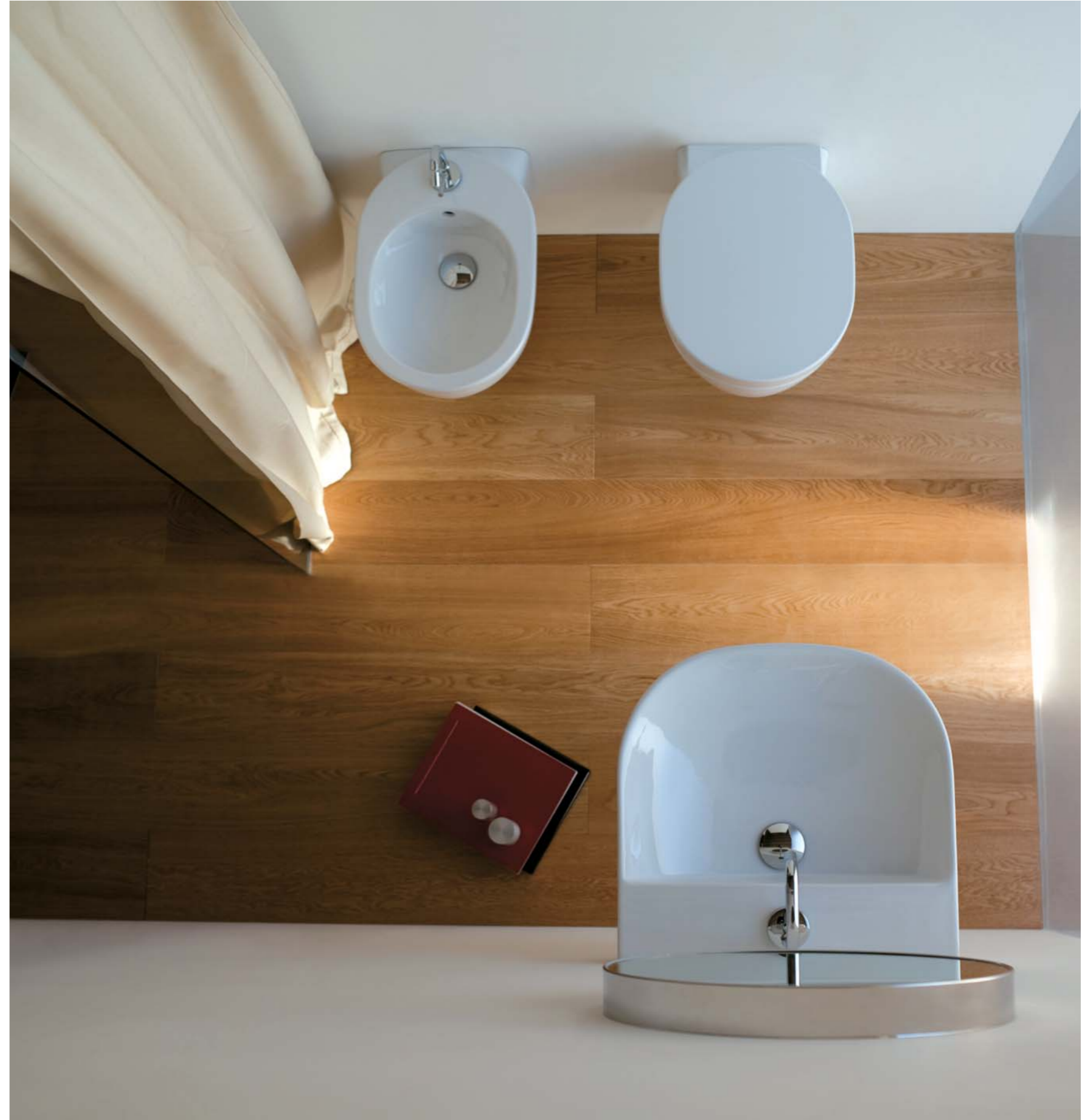



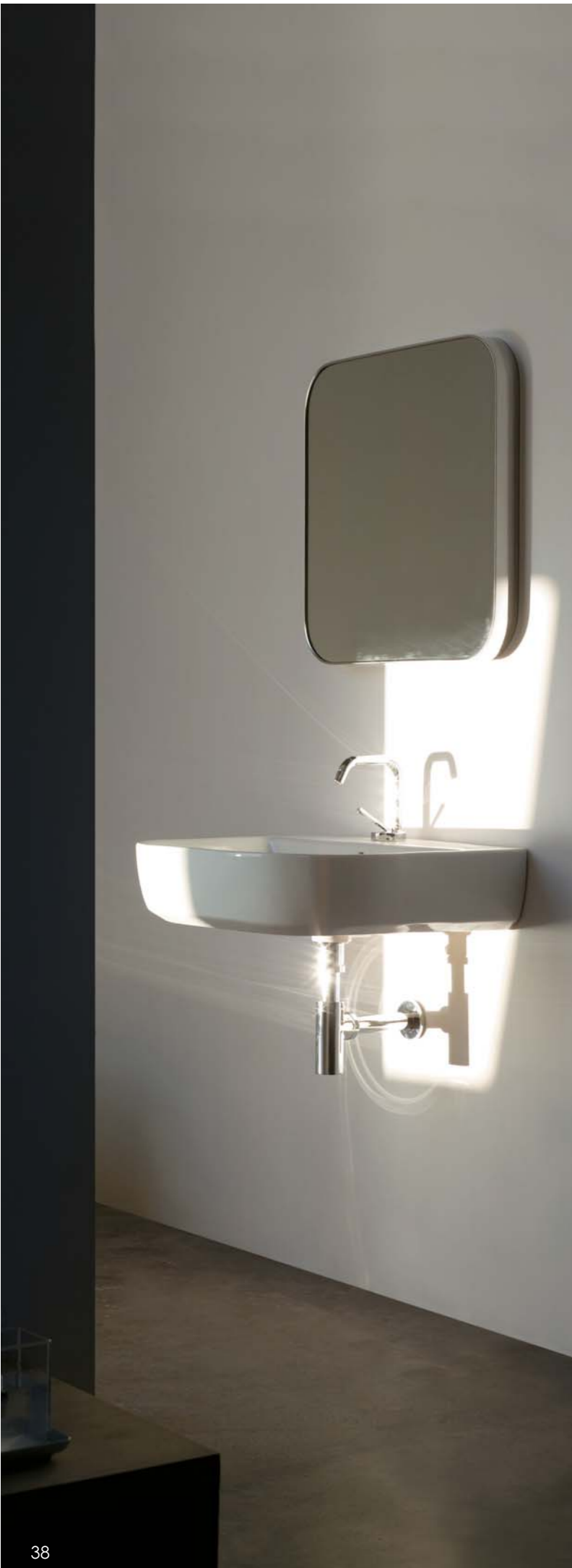

m2



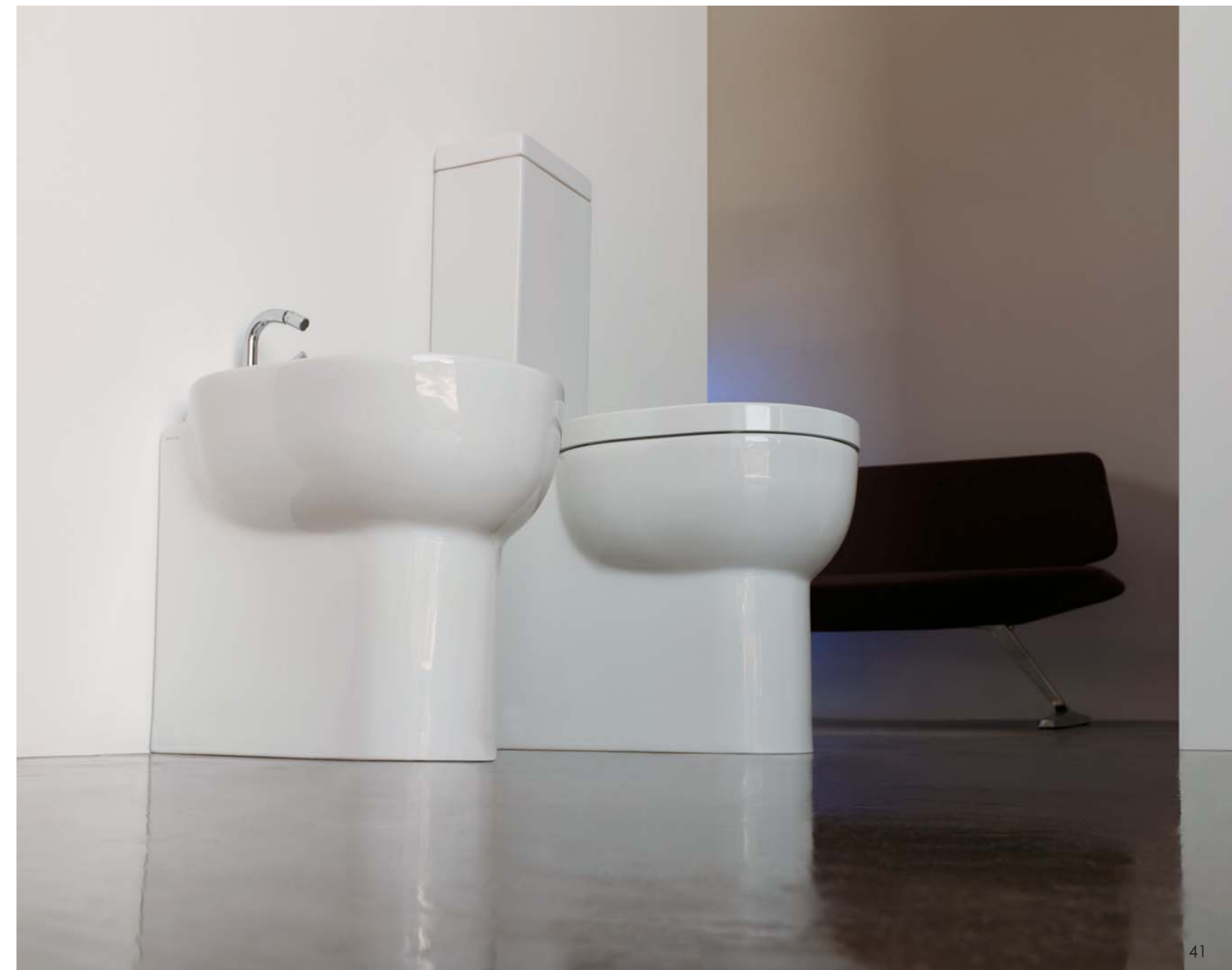



plus

design: ufficio tecnico



30x30



40x20







40x40





60x40





glamour in semplicity

55x30



technical information

Art. 1021
 H6-Flat piatto doccia cm 72x90 decoro antiscivolo.
 H6-Flat antislip texture shower tray cms 72x90.
 H6-Flat plato de ducha 72x90 cm con decoración antideslizante.

Art. 1022
 H6-Flat piatto doccia cm 75x100 decoro antiscivolo.
 H6-Flat antislip texture shower tray cms 75x100.
 H6-Flat plato de ducha 75x100 cm con decoración antideslizante.

Art. 1023
 H6-Flat piatto doccia cm 75x110 decoro antiscivolo.
 H6-Flat antislip texture shower tray cms 75x110.
 H6-Flat plato de ducha 75x110 cm con decoración antideslizante.

Art. 1024
 H6-Flat piatto doccia cm 80x120 decoro antiscivolo.
 H6-Flat antislip texture shower tray cms 80x120.
 H6-Flat plato de ducha 80x120 cm con decoración antideslizante.

Art. 1025
 H6-Flat piatto doccia cm 80x140 decoro antiscivolo.
 H6-Flat antislip texture shower tray cms 80x140.
 H6-Flat plato de ducha 80x140 cm con decoración antideslizante.

Kg. 30

Kg. 33

Kg. 35

Kg. 38

Kg. 42

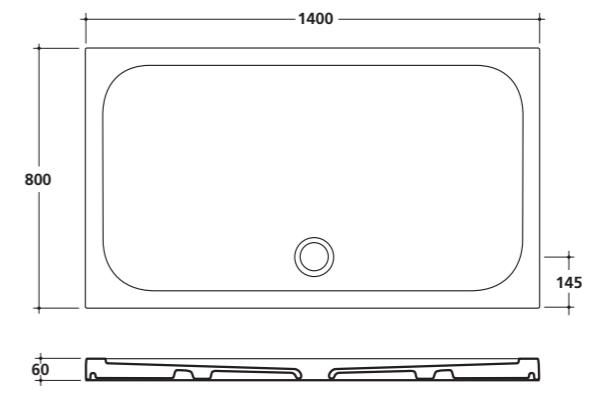
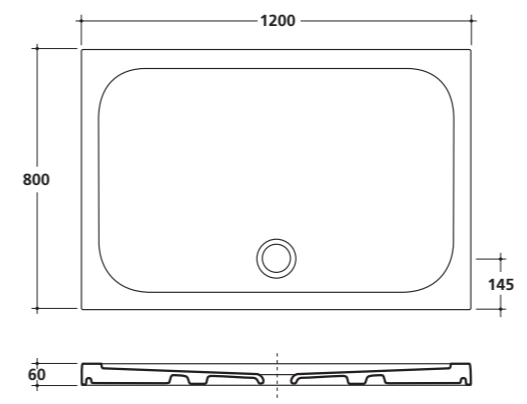
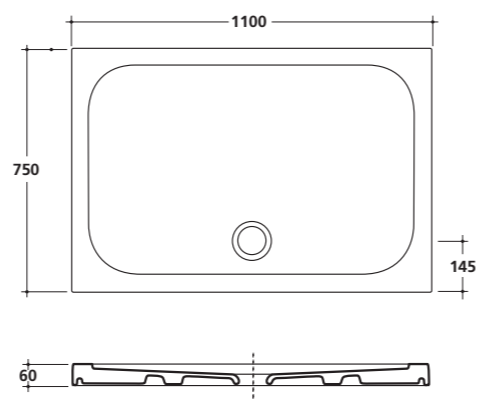
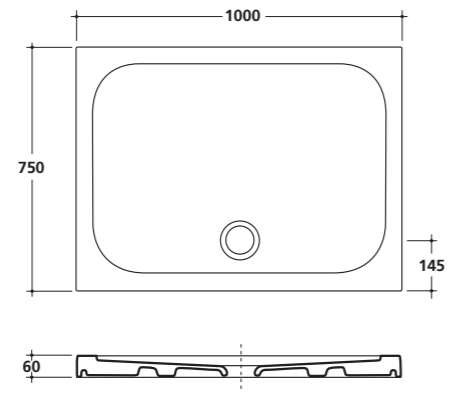
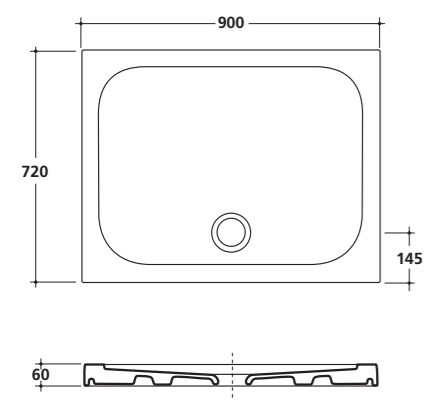

Art. 5233

Lavabo ciotola cm 54 predisposto per rubinetteria a parete o su piano. Installazione d'appoggio. Fissaggio incluso.

Bowl washbasin 54 cm arranged for wall tap or on countertop. Laid-on installation. Fixing kit included. Lavabo cuenco 54 cm para grifería a pared o sobre encimera. De apoyo. Fijaciones incluidas.

Art. 5234

Lavabo ciotola cm 70 predisposto per rubinetteria a parete o su piano. Installazione d'appoggio. Fissaggio incluso.

Bowl washbasin 70 cm arranged for wall tap or on countertop. Laid-on installation. Fixing kit included. Lavabo cuenco 70 cm para grifería a pared o sobre encimera. De apoyo. Fijaciones incluidas.

Art. 5230

Lavabo cm 60 con bacino centrale, monoforo predisposto 3 fori. Installazione sospesa. Fissaggio incluso. Washbasin 60 cm with central basin, one hole arranged for 3 tap holes. Wall-hung installation. Fixing kit included.

Lavabo 60 cm, seno central y 1 orificio premarcado para 3, suspendido. Fijaciones incluidas.

Art. 5242

Portasciugamani ottone cromato frontale per lavabo art.5230

Frontal chromium-plated brass towel-rack for washbasin art.5230

Toallero en latón cromado frontal para lavabo art.5230

Art. 5241

Portasciugamani ottone cromato laterale per lavabo art.5230

Side chromium-plated brass towel-rack for washbasin art.5230

Toallero en latón cromado lateral para lavabo art.5230

Art. 5231

Lavabo cm 75 con bacino centrale, monoforo predisposto 3 fori. Installazione sospesa. Fissaggio incluso. Washbasin 75 cm with central basin, one hole arranged for 3 tap holes. Wall-hung installation. Fixing kit included.

Lavabo 75 cm, seno central y 1 orificio premarcado para 3, suspendido. Fijaciones incluidas.

Art. 5243

Portasciugamani ottone cromato frontale per lavabo art.5231

Frontal chromium-plated brass towel-rack for washbasin art.5231

Toallero en latón cromado frontal para lavabo art.5231

Art. 5241

Portasciugamani ottone cromato laterale per lavabo art.5231

Side chromium-plated brass towel-rack for washbasin art.5231

Toallero en latón cromado lateral para lavabo art.5231

Art. 5232

Lavabo cm 90 con bacino centrale, monoforo predisposto 3 fori. Installazione sospesa. Fissaggio incluso. Washbasin 90 cm with central basin, one hole arranged for 3 tap holes. Wall-hung installation. Fixing kit included.

Lavabo 90 cm, seno central y 1 orificio premarcado para 3, suspendido. Fijaciones incluidas.

Art. 5244

Portasciugamani ottone cromato frontale per lavabo art.5232

Frontal chromium-plated brass towel-rack for washbasin art.5232

Toallero en latón cromado frontal para lavabo art.5232

Art. 5241

Portasciugamani ottone cromato laterale per lavabo art.5232

Side chromium-plated brass towel-rack for washbasin art.5232

Toallero en latón cromado lateral para lavabo art.5232

Art. 5235

Lavabo cm 85 con bacino centrale da 50 cm, monoforo predisposto 3 fori. Installazione sospesa. Fissaggio incluso.

Washbasin cm 85 with central basin 50 cm, one hole arranged for 3 tap holes. Wall-hung installation. Fixing kit included. Lavabo 85 cm, seno central de 50 cm y 1 orificio premarcado para 3, suspendido. Fijaciones incluidas.

Art. 5241

Portasciugamani ottone cromato laterale per lavabo art.5235

Side chromium-plated brass towel-rack for washbasin art.5235

Toallero en latón cromado lateral para lavabo art.5235

Kg. 10

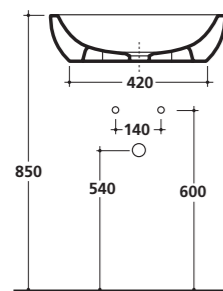
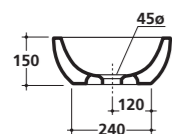
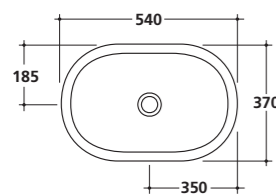

Kg. 12,5

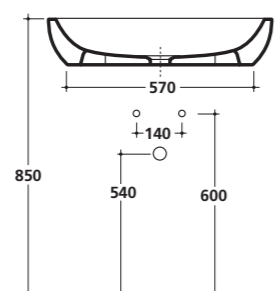
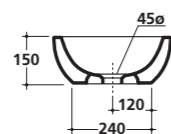
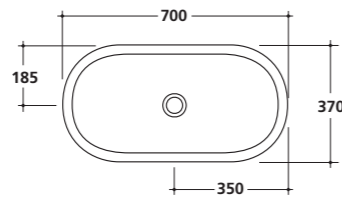
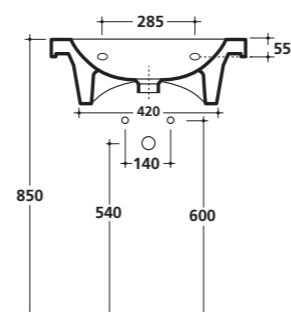
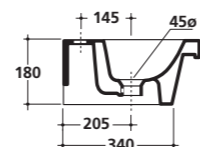
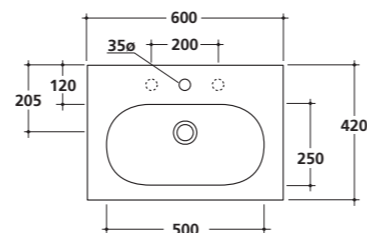
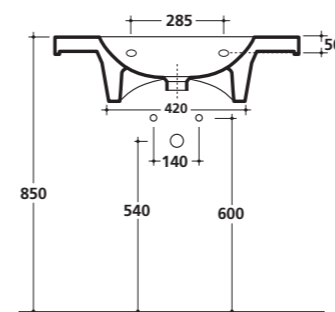
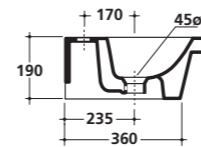
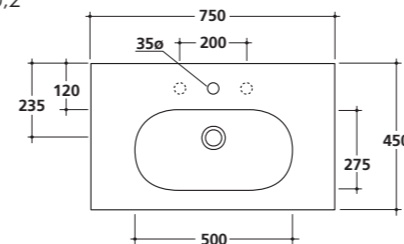
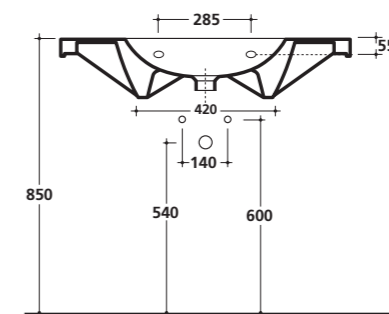
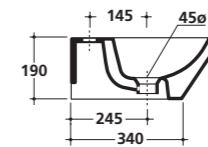
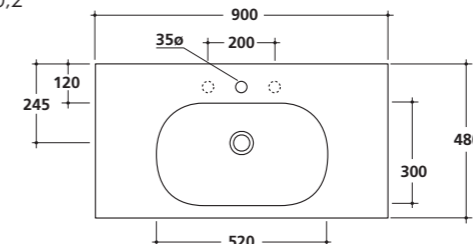
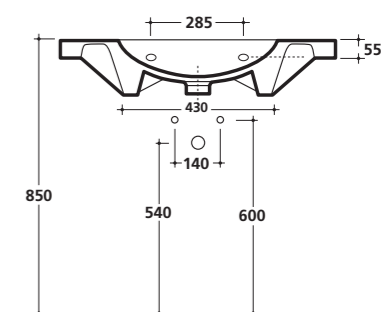
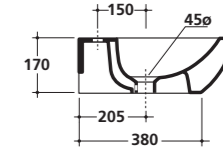
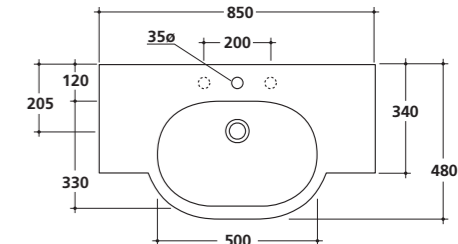
Kg. 18
Kg. 0,3
Kg. 0,2Kg. 23
Kg. 0,4
Kg. 0,2Kg. 29
Kg. 0,5
Kg. 0,2Kg. 23
Kg. 0,2

Art. 5236
 Lavabo cm 100 con bacino centrale da 50 cm, monoforo predisposto 3 fori. Installazione sospesa. Fissaggio incluso.
 Washbasin cm 100 with central basin 50 cm, one hole arranged for 3 tap holes. Wall-hung installation. Fixing kit included.
 Lavabo 100 cm, seno central de 50 cm y 1 orificio premarcado para 3, suspendido. Fijaciones incluidas.

Art. 5241
 Portasciugamani ottone cromato laterale per lavabo art.5236
 Side chromium-plated brass towel-rack for washbasin art.5236
 Toallero en latón cromado lateral para lavabo art.5236

Kg. 24,5
 Kg. 0,2

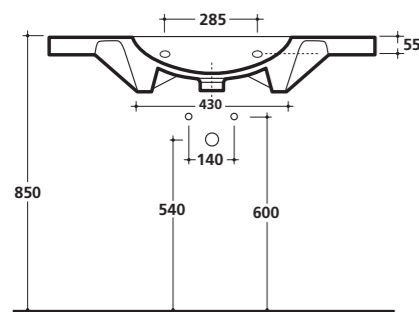
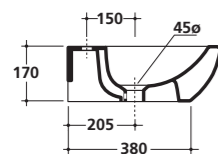
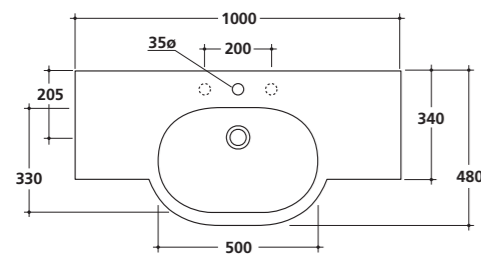

Art. 5237
 Lavabo cm 75 con bacino a destra, monoforo predisposto 3 fori. Installazione sospesa. Fissaggio incluso.
 Washbasin cm 75 with right basin, one hole arranged for 3 tap holes. Wall-hung installation. Fixing kit included.
 Lavabo 75 cm, seno a derecha y 1 orificio premarcado para 3, suspendido. Fijaciones incluidas.

Kg. 22

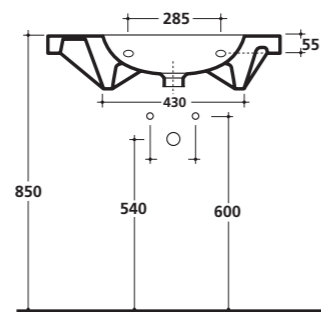
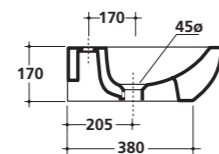
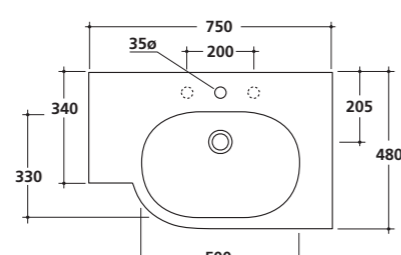

Art. 5238
 Lavabo cm 75 con bacino a sinistra, monoforo predisposto 3 fori. Installazione sospesa. Fissaggio incluso.
 Washbasin cm 75 with left basin, one hole arranged for 3 tap holes. Wall-hung installation. Fixing kit included.
 Lavabo 75 cm, seno a izquierda y 1 orificio premarcado para 3, suspendido. Fijaciones incluidas.

Kg. 22

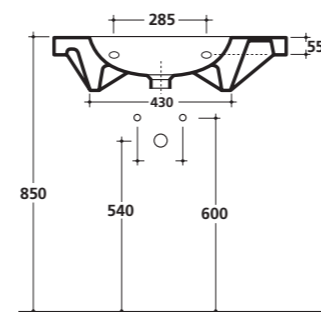
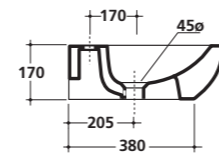
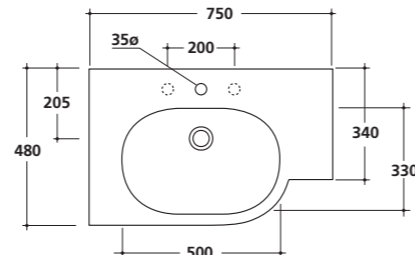

Art. 5202
 Lavabo monoforo angolare cm 45.
 Corner one-hole washbasin cm 45.
 Lavabo 1 orificio angolare cm 45.

Kg. 11,9

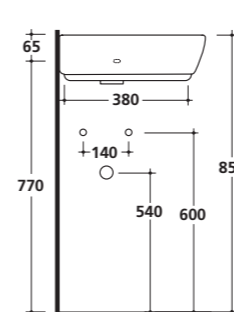
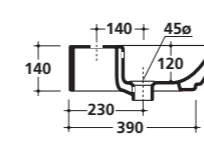
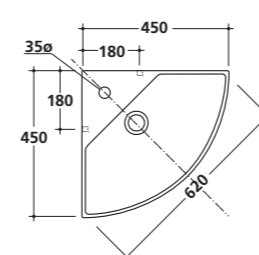

Art. 5203
 Lavabo tondo predisposto monoforo, da appoggio cm 48.
 Round laid-on washbasin cm 48 arranged one-hole.
 Lavabo redondo (premarcado 1 orificio) de apoyo cm 48.

Kg. 12,3

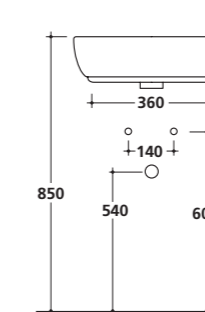
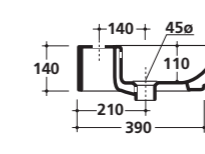
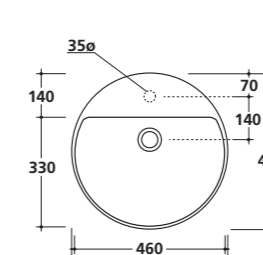

Art. 5204
 Lavabo cm 50 monoforo, predisposto 3 fori, sospeso o per colonna. Fissaggio incluso.
 Washbasin cms 50 wall-hung or for pedestal, one hole arranged 3 tap holes. Fixing kit included.
 Lavabo 50 cm 1 orificio, premarcado para 3, suspendido o para pedestal. Fijaciones incluidas.

Kg. 14
 Kg. 14
 Kg. 9

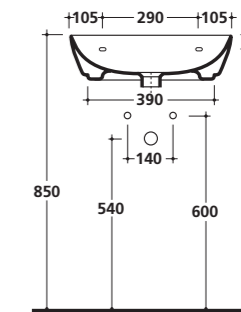
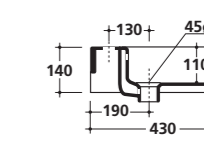
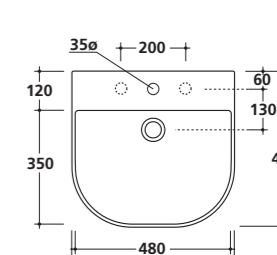

Art. 9919
 Colonna per art. 5204
 Pedestal for item 5204
 Pedestal para art. 5204

Art. 5240
 Colonna per art. 5204
 Pedestal for item 5204
 Pedestal para art. 5204

Art. 5207

Lavabo cm 50 da appoggio, rettificato, monoforo, predisposto tre fori. Fissaggio incluso.
Laid-on washbasin cms 50, one hole arranged for 3 tap holes, rectified. Fixing kit included.
Lavabo 50 cm 1 orificio, premarcado para 3, de apoyo, rectificado. Fijaciones incluidas.

Art. 5208

Lavabo cm 60 monoforo, predisposto 3 fori, sospeso o per colonna. Fissaggio incluso.
Washbasin cms 60 wall-hung or for pedestal, one hole arranged 3 tap holes. Fixing kit included.
Lavabo 60 cm 1 orificio, premarcado para 3, suspendido o para pedestal. Fijaciones incluidas.

Art. 5206

Lavabo cm 60 da appoggio, monoforo predisposto tre fori, rettificato. Fissaggio incluso.
Laid-on washbasin cms 60, one hole arranged 3 tap holes, rectified. Fixing kit included.
Lavabo 60 cm 1 orificio, premarcado para 3, de apoyo, rectificado. Fijaciones incluidas.

Art. 5209

Lavabo cm 70 monoforo, predisposto 3 fori, sospeso o per colonna. Fissaggio incluso.
Washbasin cms 70 wall-hung or for pedestal, one hole arranged 3 tap holes. Fixing kit included.
Lavabo 70 cm 1 orificio, premarcado para 3, suspendido o para pedestal. Fijaciones incluidas.

Art. 5239

Lavabo cm 65 monoforo, predisposto 3 fori, sospeso o per colonna. Fissaggio incluso.
Washbasin cms 65 wall-hung or for pedestal, one hole arranged 3 tap holes. Fixing kit included.
Lavabo 65 cm 1 orificio, premarcado para 3, suspendido o para pedestal. Fijaciones incluidas.

Art. 9919

Colonna per art. 5205
Pedestal for item 5205
Pedestal para art. 5205

Art. 5240

Colonna per art. 5205
Pedestal for item 5205
Pedestal para art. 5205

Art. 9919

Colonna per art. 5206
Pedestal for item 5206
Pedestal para art. 5206

Art. 5240

Colonna per art. 5206
Pedestal for item 5206
Pedestal para art. 5206

Art. 5240

Colonna per art. 5239
Pedestal for item 5239
Pedestal para art. 5239

Kg. 14

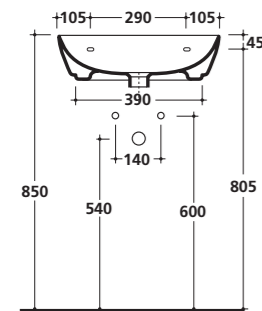
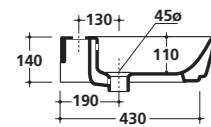
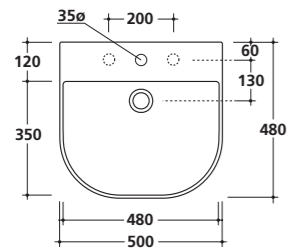
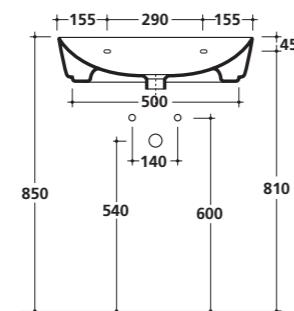
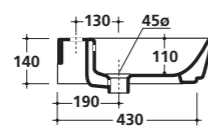
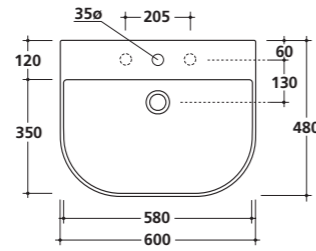
Kg. 16
Kg. 14
Kg. 9

Kg. 16

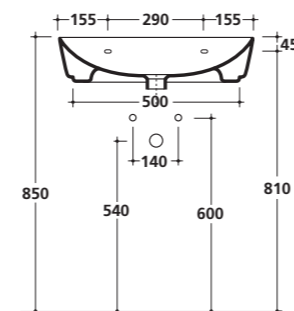
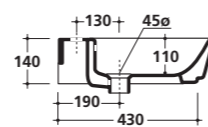
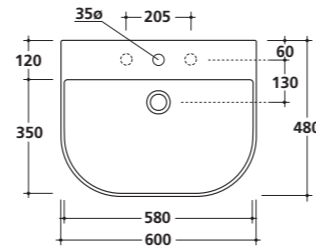
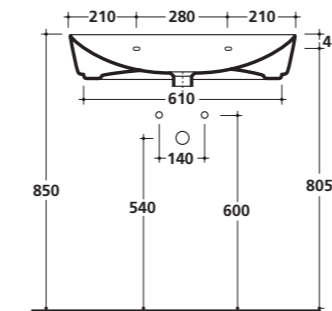
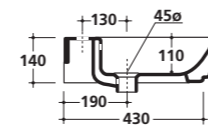
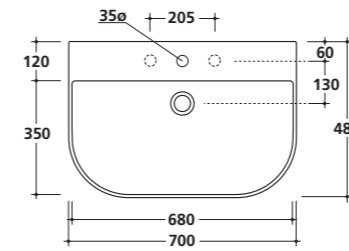
Kg. 18
Kg. 14
Kg. 9

Kg. 18

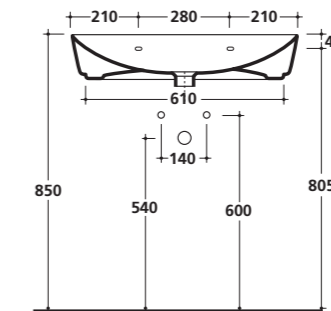
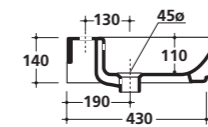
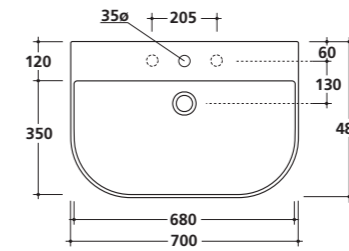
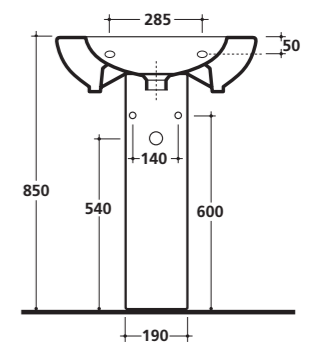
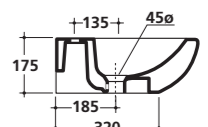
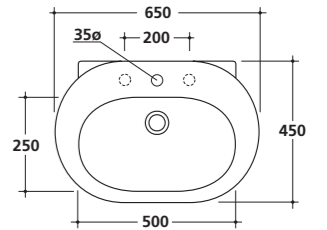
Kg. 17
Kg. 9

Art. 5240
 Colonna per art. 5239
 Pedestal for item 5239
 Pedestal para art. 5239

Art. 9919
 Colonna per art. 5204 - 5205 - 5206.
 Pedestal for art. 5204 - 5205 - 5206.
 Pedestal para art. 5204 - 5204 - 5206.

Art. 5213
 Bidet monoforo cm 45.
 Bidet one-hole cm 45.
 Bidé 1 agujero cm 45.

Art. 5211
 Vaso con scarico "S" cm 45.
 W.c. with floor draining cm 45.
 Inodoro para tanque alto salida vertical cm 45.

Art. 5212
 Vaso con scarico "P" cm 45.
 W.c. with wall draining cm 45.
 Inodoro para tanque alto salida horizontal cm 45.

Kg. 9

Kg. 14

Kg. 21

Kg. 25

Kg. 24

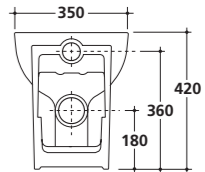
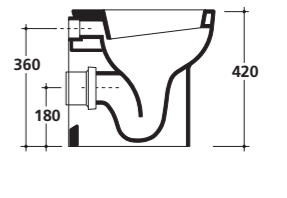
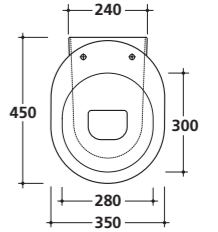
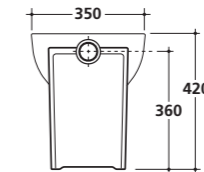
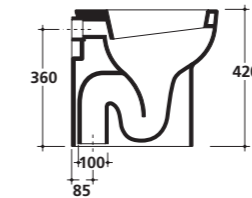
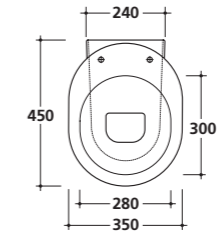
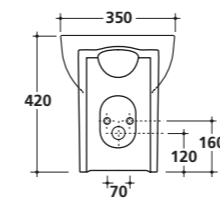
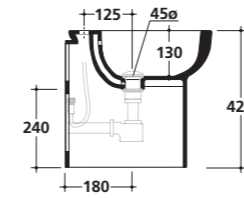
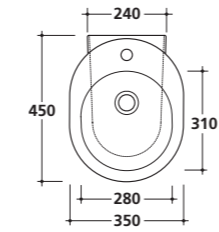
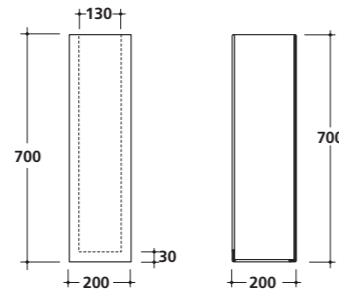
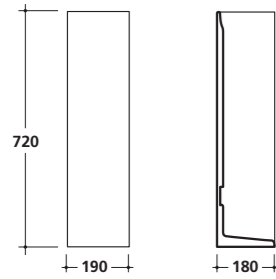
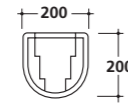
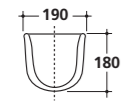

Art. 5215

Bidet monoforo cm 50.
Bidet one-hole cm 50.
Bidé 1 agujero cm 50.

Kg. 25

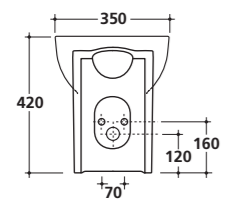
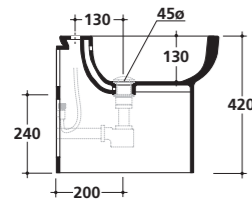
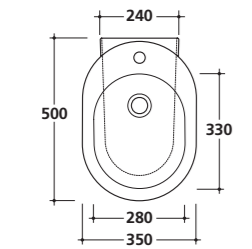
**Art. 5214**

Vaso con scarico universale "S/P" cm 50.
W.c. with floor/wall draining cm 50.
Inodoro cm 50 para tanque alto
salida vertical ó horizontal.

Kg. 27

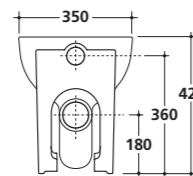
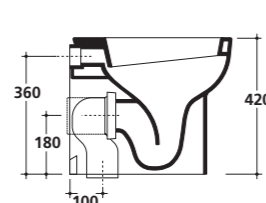
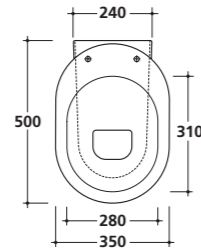
**Art. 5217**

Bidet monoforo cm 55.
Bidet one-hole cm 55.
Bidé 1 agujero cm 55.

Kg. 26

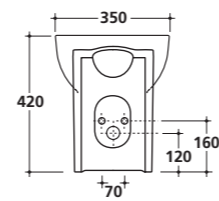
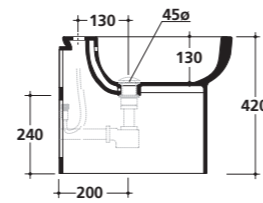
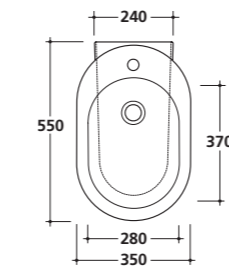
**Art. 5216**

Vaso con scarico universale "S/P" cm 55.
W.c. with floor/wall draining cm 55.
Inodoro cm 55 para tanque alto
salida vertical ó horizontal.

Kg. 28

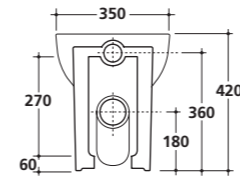
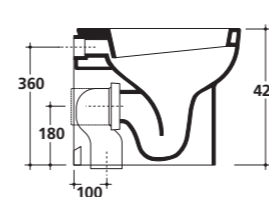
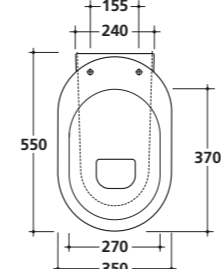
**Art. 5220**

Vaso monoblocco con scarico universale "S/P" cm 60.
W.c. monoblock with floor/wall draining cm 60.
Inodoro cm 60 para tanque bajo
salida vertical ó horizontal.

Kg. 29

Kg. 11,5

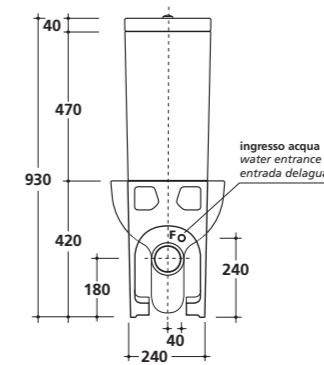
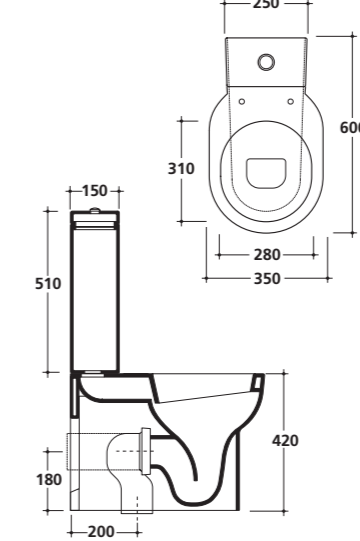
**Art. 5221**

Vaso monoblocco con scarico universale "S/P" cm 65.
W.c. monoblock with floor/wall draining cm 65.
Inodoro cm 65 para tanque bajo
salida vertical ó horizontal.

Kg. 30

Kg. 11,5

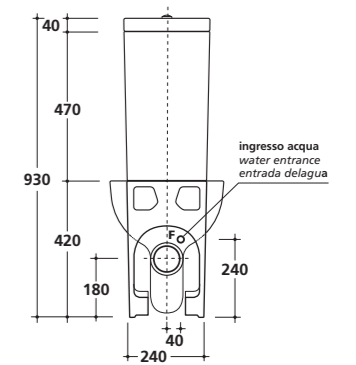
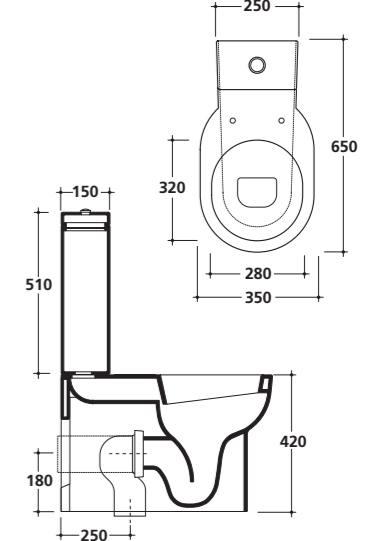

Art. 5219

Bidet monoforo sospeso cm 50.
Wall-hung bidet one-hole cm 50.
Bidé suspendido cm 50 1 orificio.

Art. 5218

Vaso sospeso cm 50.
Wall-hung w.c. cm 50.
Inodoro suspendido cm 50.

Kg. 16

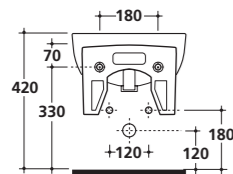
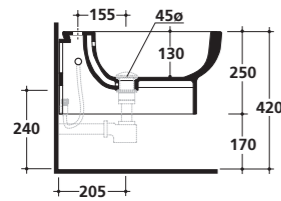
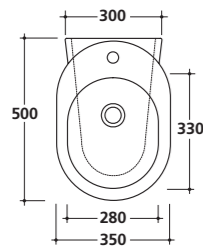

Kg. 16

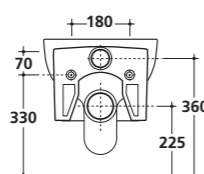
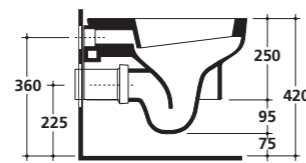
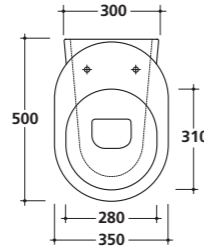
**Art. 5223**

Coprivaso in termoindurente. Cerniera con dispositivo di caduta rallentata per art. 5211 - 5212 - 5220.
Thermosetting seat-cover with soft closing system for codes 5211 - 5212 - 5220.
Tapa inodoro termoendurecida, bisagra de caída amortiguada para art. 5211 - 5212 - 5220.
Kg. 1,9

Art. 5226

Coprivaso avvolgente in termoindurente per art. 5211 - 5212 - 5220.
Thermosetting wrap around seat-cover for codes 5211 - 5212 - 5220.
Tapa inodoro termoendurecida para art. 5211 - 5212 - 5220.
Kg. 2,3

Art. 5224

Coprivaso in termoindurente. Cerniera con dispositivo di caduta rallentata per art. 5214 - 5218 - 5221.
Thermosetting seat-cover with soft closing system for codes 5214 - 5218 - 5221.
Tapa inodoro termoendurecida, bisagra de caída amortiguada para art. 5214 - 5218 - 5221.
Kg. 2,3

Art. 5227

Coprivaso avvolgente in termoindurente per art. 5214 - 5218 - 5221.
Thermosetting wrap around seat-cover for codes 5214 - 5218 - 5221.
Tapa inodoro termoendurecida para art. 5214 - 5218 - 5221.
Kg. 1,9

Art. 5225

Coprivaso in termoindurente. Cerniera con dispositivo di caduta rallentata per art. 5216.
Thermosetting seat-cover with soft closing system for code 5216.
Tapa inodoro termoendurecida, bisagra de caída amortiguada para art. 5216.
Kg. 1,9

Art. 5228

Coprivaso avvolgente in termoindurente per art. 5216.
Thermosetting wrap around seat-cover for code 5216.
Tapa inodoro termoendurecida para art. 5216.
Kg. 1,9



Kg. 9

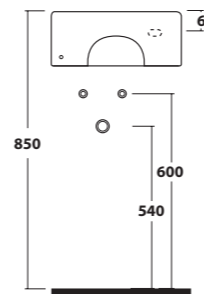
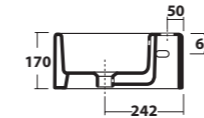
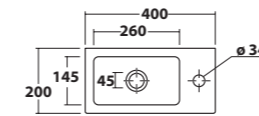

Kg. 9

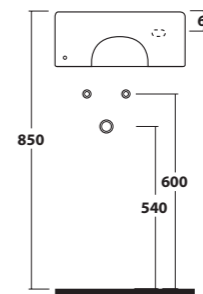
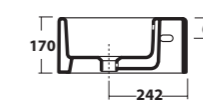
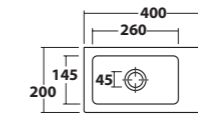

Kg. 11

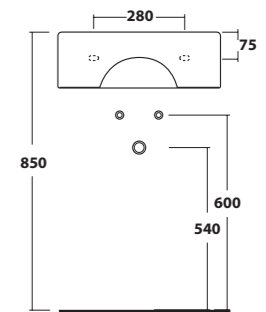
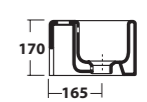
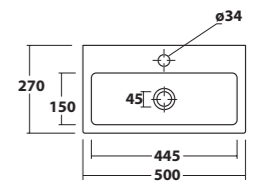

Art. 6031

Lavabo cm 50x27 senza foro rubinetteria. Installazione sospesa o d'appoggio. Fissaggio incluso. Washbasin 50x27 cm without tap hole. Wall-hung or laid-on installation. Fixing kit included. Lavabo 50x27 cm sin orificio. Suspendido o de apoyo. Fijaciones incluidas.

Art. 6032M

Lavabo cm 60x40 monoforo predisposto 3 fori. Installazione sospesa o d'appoggio. Fissaggio incluso. Washbasin 60x40 cm one hole arranged 3 holes. Wall-hung or laid-on installation. Fixing kit included. Lavabo 60x40 cm 1 orificio premarcado para 3. Suspendido o de apoyo. Fijaciones incluidas.

Art. 6032

Lavabo cm 60x40 senza foro rubinetteria. Installazione sospesa o d'appoggio. Fissaggio incluso. Washbasin 60x40 cm without tap hole. Wall-hung or laid-on installation. Fixing kit included. Lavabo 60x40 cm sin orificio. Suspendido o de apoyo. Fijaciones incluidas.

Art. 6035

Lavabo cm 55x30 con bacino da 32 cm, predisposto per rubinetteria monoforo destra o sinistra e da parete. Installazione sospesa e in appoggio. Fissaggio incluso. Washbasin 55x30 cm with 32 cm basin, arranged with 1 tap hole right or left and to wall. Wall-hung or laid-on installation. Fixing kit included. Lavabo 55x30 cm, seno de 32 cm y orificio para grifería a la derecha o a la izquierda o de pared. Suspendido o de apoyo. Fijaciones incluidas.

Art. 6036

Lavabo cm 75x30 con bacino da 52 cm, predisposto per rubinetteria monoforo destra o sinistra e da parete. Installazione sospesa e in appoggio. Fissaggio incluso. Washbasin 75x30 cm with 52 cm basin, arranged with 1 tap hole right or left and to wall. Wall-hung or laid-on installation. Fixing kit included. Lavabo 75x30 cm, seno de 52 cm y orificio para grifería a la derecha o a la izquierda o de pared. Suspendido o de apoyo. Fijaciones incluidas.

Kg. 11

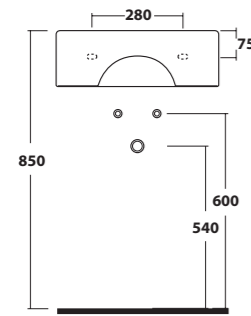
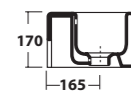
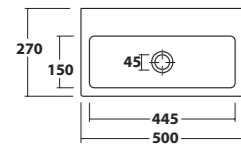

Kg. 19

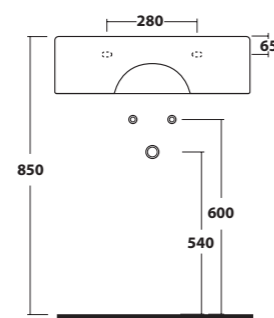
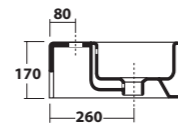
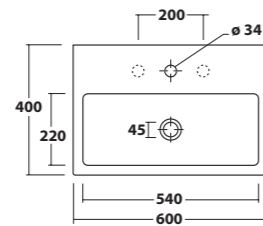

Kg. 19

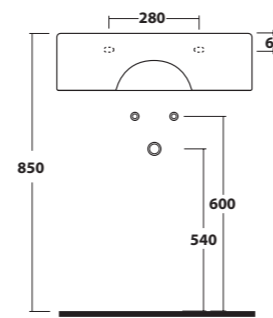
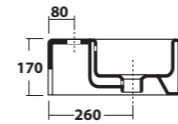
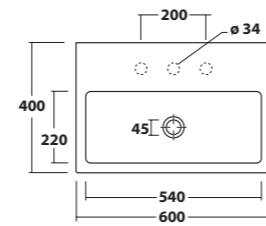

Kg. 10

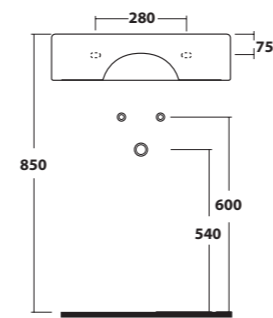
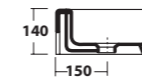
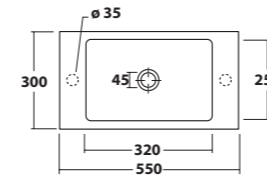

Kg. 13

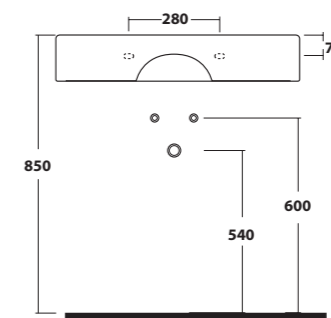
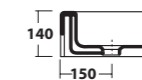
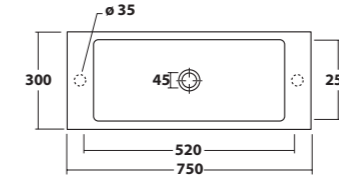

Art. 6034M

Lavabo cm 40x40 monoforo. Installazione sospesa o d'appoggio. Fissaggio incluso.
 Washbasin 40x40 cm, one tap hole. Wall-hung or laid-on installation. Fixing kit included.
 Lavabo 40x40 cm, 1 orificio. Suspendido o de apoyo. Fijaciones incluidas.

Art. 6034

Lavabo cm 40x40 senza foro rubinetteria. Installazione sospesa o d'appoggio. Fissaggio incluso.
 Washbasin 40x40 cm without tap hole. Wall-hung or laid-on installation. Fixing kit included.
 Lavabo 40x40 cm sin orificio. Suspendido o de apoyo. Fijaciones incluidas.

Art. 6033M

Lavabo cm 30x30 monoforo. Installazione sospesa o d'appoggio. Fissaggio incluso.
 Washbasin 30x30 cm, one tap hole. Wall-hung or laid-on installation. Fixing kit included.
 Lavabo 30x30 cm, 1 orificio. Suspendido o de apoyo. Fijaciones incluidas.

Art. 6033

Lavabo cm 30x30 senza foro rubinetteria. Installazione sospesa o d'appoggio. Fissaggio incluso.
 Washbasin 30x30 cm without tap hole. Wall-hung or laid-on installation. Fixing kit included.
 Lavabo 30x30 cm sin orificio. Suspendido o de apoyo. Fijaciones incluidas.

Art. 6022

Febbe lavabo quadrato d'appoggio o sospeso con bacino rettangolare con foro. Fissaggio incluso.
 Febe deep square countertop or wall-hung washbasin with rectangular basin with hole. Fixing kit included.
 Lavabo Febe cuadrado de apoyo con seno rectangular con orificio. Fijaciones incluidas.

Art. 6022SF

Febbe lavabo quadrato d'appoggio o sospeso con bacino rettangolare senza foro. Fissaggio incluso.
 Febe deep square countertop or wall-hung washbasin without rectangular basin without hole. Fixing kit included.
 Lavabo Febe cuadrado de apoyo con seno rectangular sin orificio. Fijaciones incluidas.

Kg. 12

Kg. 12

Kg. 11

Kg. 8

Kg. 19

Kg. 19

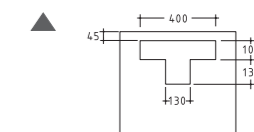
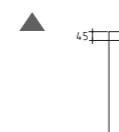
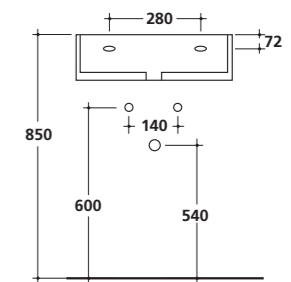
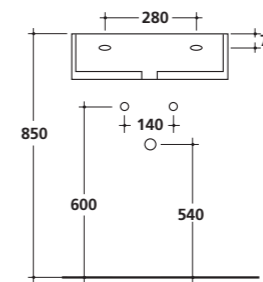
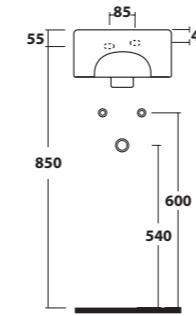
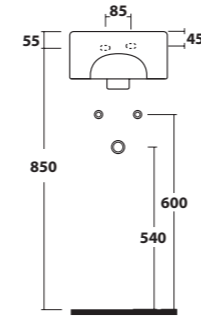
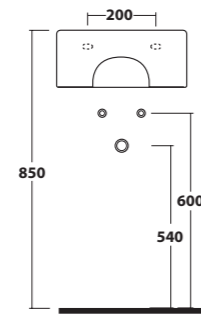
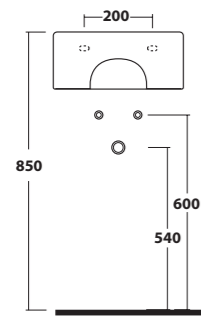
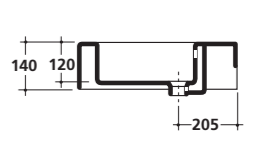
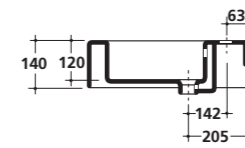
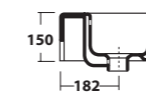
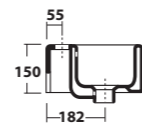
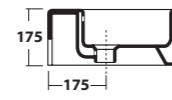
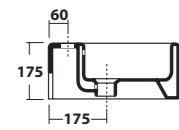
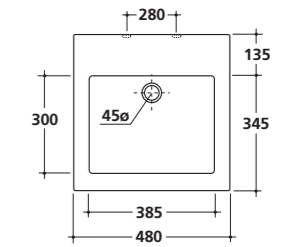
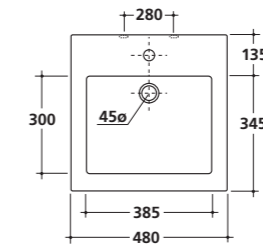
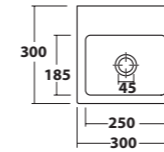
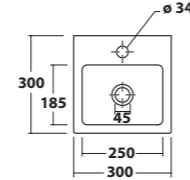
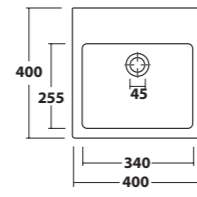
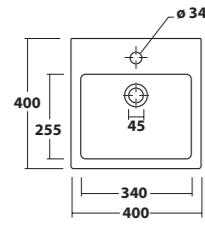

art direction, concept and styling: david dolcini

fotografie: fabrizio faedda

stampa: telligraf

thanks to:
Crassevig
Fabas Luce
Gal
Luceplan
Riva 1920
Webert
Zucchetti

and to:
Benuzzi Pietro

edizione n.1 05/2009