



El nuevo proyecto de diseño industrial MEG11 nace de la búsqueda de soluciones formales inéditas, caracterizándose de formas y señales que evidencian la emoción y la poesía de los propios objetos como símbolos que trascienden su propia naturaleza funcional. Cada objeto, además de la característica de su fuerte personalidad, se convierte en un ente con vida propia.

La nueva colección de sanitario MEG11, evidenciando una dimensión evocativa, presta atención a la forma y interpreta la materia cerámica para fundirla en su elaboración, como por ejemplo el toallero, con forma de rama, que se plasma sin preguntar en la cerámica que no es de su propia naturaleza.

Los sanitarios que han hecho de modelo para toda la colección se presentan esenciales, limpios, etéreos; con formas simples, elementales, que se integran perfectamente con otros artículos elementales de la serie, como el lavabo monolito, realizado también en la inédita solución de madera.

Buscando la nueva funcionalidad también creamos el lavabo-lavadero (un objeto considerado hoy en día solo por su funcionalidad) valorizado como un elemento que se intenta introducir también en un ambiente decorativo..

Meg 11, the New Industrial design project, born from the research of new formal solutions, is characterized by shapes and lines which emphasize the pathos and the poetry of objects, symbols that transcend their functional nature.

The new collection Meg 11, despite its evocative dimension, gives the shape a particular attention. Besides the linear shaped sanitary ware, combining complementary bathroom fittings with an optional tree limb shaped towel rack, enhance its natural line.

Meg 11 with its essential and clean ethereal lines: shapes are simple and complement other optional items, such as the wood monolith washbasin.

The washbasin-wash tub, considered until now an item only linked to its proper function, is here shown as an interior decorative element.

Design Antonio Pascale

MEG11

Il nuovo progetto di industrial design MEG11 nasce dalla ricerca di inedite soluzioni formali, caratterizzato da forme e segni che evidenziano l'emozionalità e la poetica degli oggetti stessi intesi come simboli che trascendono la loro natura funzionale. Ogni oggetto, oltre che caratterizzato dalla forte personalità, diventa tanto più credibile se porta la memoria di un racconto.

La nuova collezione di sanitari MEG11, pur evidenziando la dimensione evocativa, presta attenzione alla forma e interpreta la materia ceramica per assecondarla nella sua lavorazione come per esempio il portasciugamani, dalla forma di un ramo, che si plasma senza chiedere alla ceramica quella planarità che non è nella sua natura.

I sanitari che hanno fatto da modello a tutta la collezione si presentano essenziali, puliti, eterei; forme semplici, elementari, che si integrano perfettamente con gli altri elementi della serie come il lavabo monolite, realizzato anche nella inedita soluzione di legno. Ricerca di nuove funzionalità anche per l'elemento lavabo-lavatoio (un oggetto considerato fino ad oggi solo per la sua funzione) valorizzato come elemento con l'intento di introdurlo anche in un ambito di arredamento.



@ galassia

art. 5405P - 50x40xh86

***Lavabo Monolite, scarico a parete**
**Monolith washbasin, wall drain*
**Monolito lavabo, descarga a pared*

art. 5446

**Miscelatore monocomando per
lavabo incasso muro**
Concealed single lever washbasin mixer
Monomando empotrable de pared

art. 5412 - 55x35

Bidet sospeso monoforo.
Wall-hung bidet, one hole.
Bidet suspendido, 1 orificio.

art. 5411 - 55x35

Vaso sospeso.
Wall-hung wc.
Inodoro suspendido.

art. 5444

Miscelatore monocomando per bidet .
Single lever bidet mixer.
Monomando para bidet .

***Disponibile con scarico a pavimento**
**Available with floor drain*
**Disponible con descarga a suelo*

MEG11

art. 5406S - 50x40xh86

***Lavabo Monolite in legno Iroko.**
Installazione free standing.
**Iroko wooden Monolith washbasin.*
Free standing.
**Monolito lavabo en madera de Iroko.*
Instalación free standing.

art. 5442 - h105

**Miscelatore monocomando
free standing per lavabo.**
Free standing single lever basin mixer.
Monomando para lavabo free standing.



***Disponibile con scarico a parete**
**Available with wall drain*
**Disponible con descarga a pared*

@ galassia

art. 5404R - 50x40xh86
90x36xh8 mensola/shelf/repisa

***Lavabo Monolite, bianco, completo di mensola in MDF verniciata lucida, finitura termoindurente.**

**Monolith washbasin, white, with MDF wooden shelf, glossy varnished, thermosetting finishing.
Monolito lavabo, bianco, con repisa in DM, barnizada brilla, acabado termoindurente.

art. 5418 - 188x88

Vasca in Pietraluce® senza troppopieno. Installazione free standing.

*Pietraluce® bathtub, without overflow.
Free standing installation.
Bañera en Pietraluce®, sin rebosadero.
Instalación free standing.*



art. 5449
Miscelatore monocomando free standing per vasca.
*Free standing single lever bathtub mixer.
Monomando para bañera free standing.*

art. 5443
Miscelatore monocomando per lavabo alto senza scarico.
*High single lever washbasin mixer without pop-up waste.
Monomando para lavabo alto, sin desagüe.*

***Disponibile con scarico a pavimento**
**Available with floor drain
Disponibile con descarga a suelo

MEG11

art. 5404NE - 50x40xh86

Lavabo Monolite, nero, completo di mensola in MDF, verniciata lucida, finitura termoindurente.
*Monolith washbasin, black, with MDF wooden shelf, glossy varnished, thermosetting finishing.
Monolito lavabo, negro, con repisa en DM, barnizada brilla, acabado termoindurente.*





MEG11

art. 5406S - 50x40xh86

Lavabo Monolite in legno Iroko.
Installazione Free standing.
Iroko wooden Monolith washbasin.
Free standing installation.
Monolito lavabo en madera de Iroko.
Instalación free standing.

art. 5442 - h105

Miscelatore monocomando free standing per lavabo.
Free standing single lever basin mixer.
Monomando para lavabo free standing.

art. 5412 - 55x35

Bidet sospeso monoforo.
Wall-hung bidet, one hole.
Bidet suspendido 1 orificio.

art. 5411 - 55x35

Vaso sospeso.
Wall-hung wc.
Inodoro suspendido.

art. 5444

Miscelatore monocomando per bidet.
Single lever bidet mixer.
Monomando para bidet.



art. 5412 - 55x35

Bidet sospeso monoforo.
Wall-hung bidet, one hole.
Bidet suspendido, 1 orificio.

art. 5411 - 55x35

Vaso sospeso.
Wall-hung wc.
Inodoro suspendido.

art. 5444

Miscelatore monocomando per bidet .
Single lever bidet mixer.
Monomando para bidet.



@ galassia

art. 5412 - 55x35

Bidet sospeso monoforo.
Wall-hung bidet, one hole.
Bidet suspendido, 1 orificio.

art. 5444

Miscelatore monocomando per bidet .
Single lever bidet mixer.
Monomando para bidet.

art. 5411 - 55x35

Vaso sospeso.
Wall-hung wc.
Inodoro suspendido.



MEG11

art. 5423

Portarotolo in ceramica.
Ceramic toilet roll-holder.
Portarollos en cerámica.



@ galassia

art. 5409 - 55x35

Vaso con scarico universale S/P.
Back to wall wc with floor/wall draining.
Inodoro de tanque alto salida universal.

art. 5410 - 55x35

Bidet monoforo.
Back to wall bidet, one hole.
Bidet 1 orificio.

art. 5444

Miscelatore monocomando per bidet.
Single lever bidet mixer.
Monomando para bidet.



MEG11

art. 5413 - 70x35
art. 5414 - 29x16xh50

Vaso monoblocco con cassetta.
Close coupled toilet, wall/floor draining and ceramic cistern.
Inodoro de tanque bajo, salida universal, y tanque cerámico.



art. 5409 - 55x35

Vaso con scarico universale S/P.
Back to wall wc with floor/wall draining.
Inodoro de tanque alto salida universal.

art. 5410 - 55x35

Bidet monoforo.
Back to wall bidet, one hole.
Bidet 1 orificio.

art. 5444

Miscelatore monocomando per bidet.
Single lever bidet mixer.
Monomando para bidet.





art. 5408 - 35x35

Orinatoio sospeso.
Wall mounted urinal.
Urinario suspendido.



@ galassia

art. 5407SF - 45x40xh59

Lavabo sospeso, senza foro rubinetteria, bianco.
Wall-hung washbasin, without tap hole, white.
Lavabo suspendido sin orificio, blanco.

art. 5446

Miscelatore monocomando per lavabo incasso muro.
Concealed single lever washbasin mixer.
Monomando empotrable de pared.

art. 5411 - 55x35

Vaso sospeso.
Wall-hung wc.
Inodoro suspendido.

art. 5412 - 55x35

Bidet sospeso monoforo.
Wall-hung bidet, one hole.
Bidet suspendido, 1 orificio.

art. 5444

Miscelatore monocomando per bidet.
Single lever bidet mixer.
Monomando para bidet.

art. 5407NE - 45x40xh59

Lavabo sospeso, monoforo, nero.
Wall-hung washbasin, one hole, black.
Lavabo suspendido, 1 orificio, negro.

art. 5445

Miscelatore monocomando per lavabo.
Single lever washbasin mixer.
Monomando para lavabo.



@ galassia

art. 5401M - 75x44

Lavabo sospeso monoforo.
Wall-hung washbasin, one hole.
Lavabo suspendido 1 orificio.

art. 5440

Portasciugamani in ottone cromato cm55
Chromium-plated brass towel-rack, 55cms.
Toallero en latón cromado, 55cm.



MEG11

art. 5400M - 85x44

Lavabo sospeso monoforo.
Wall-hung washbasin, one hole.
Lavabo suspendido 1 orificio.

art. 5401M - 75x44

Lavabo sospeso monoforo.
Wall-hung washbasin, one hole.
Lavabo suspendido 1 orificio.

art. 5402M - 65x44

Lavabo sospeso monoforo.
Wall-hung washbasin, one hole.
Lavabo suspendido 1 orificio.

85



75



65





@ galassia

art. 5400M - 85x44

Lavabo sospeso monoforo.
Wall-hung washbasin, one hole.
Lavabo suspendido, 1 orificio.

art. 5445

Miscelatore monocomando per lavabo.
Single lever washbasin mixer.
Monomando para lavabo.

art. 5412 - 55x35

Bidet sospeso monoforo.
Wall-hung bidet, one hole.
Bidet suspendido, 1 orificio.

art. 5411 - 55x35

Vaso sospeso.
Wall-hung wc.
Inodoro suspendido.

art. 5444

Miscelatore monocomando per bidet.
Single lever bidet mixer.
Monomando para bidet.

MEG11

art. 5401M - 75x44

Lavabo sospeso monoforo.
Wall-hung washbasin, one hole.
Lavabo suspendido, 1 orificio.



art. 5403 - 65x45

Lavabo-lavatoio. Rubinetteria a parete.
Wall-hung washbasin-washtub, wall tap.
Lavabo-lavadero, grifería a pared.

art. 5442

Asse in legno di frassino.
Ash wooden board.
Tabla en madera de fresno.



art. 5403 - 65x45

Lavabo-lavatoio. Rubinetteria a parete.
Wall-hung washbasin-washtub, wall tap.
Lavabo-lavadero, griferia a pared.

art. 5442

Asse in legno di frassino.
Ash wooden board.
Tabla en madera de fresno.

art. 5446

**Miscelatore monocomando per lavabo
incasso muro.**
Concealed single lever washbasin mixer.
Monomando empotrable de pared.



art. 5418 - 188x88

Vasca in Pietraluce®, senza troppopieno, installazione free standing.
Pietraluce® bathtub, without overflow. Free standing installation.
Bañera en Pietraluce® , sin rebosadero. Instalación free standing.



@ galassia

art. 5418 - 188x88

Vasca in Pietraluce®, senza troppopieno,
installazione free standing.

*Pietraluce® bathtub, without overflow. Free
standing installation.*

*Bañera en Pietraluce®, sin rebosadero.
Instalación free standing.*

art. 5449 - h80

**Miscelatore monocomando
free standing per vasca.**

*Free standing single lever bathtub mixer.
Monomando para bañera free standing.*



MEG11





galassia

art. 5406S - 50x40xh86

*Lavabo Monolite in legno Iroko.
Installazione free standing.
*Iroko wooden Monolith washbasin.
Free standing.
*Monolito lavabo en madera de Iroko.
Instalación free standing.

art. 1022 - 75x100xh6

Piatto doccia in ceramica
con decoro antiscivolo.
Ceramic shower tray with
antiskid texture.
Plato de ducha en cerámica
con decoración antideslizante.

art. 5442 - h105

Miscelatore monocomando
free standing per lavabo.
Free standing single lever basin mixer.
Monomando para lavabo free standing.



*Disponibile con scarico a parete
*Available with wall drain
*Disponible con descarga a pared

MEG11

Piatti doccia in ceramica, H6.
Ceramic shower trays, H6.
Platos de ducha en cerámica, H6.

80 100 - 120 - 140



75 100 - 110



72 90



90 90





MEG11

art. 5417 - 50x38xh7

Lavabo da appoggio soprapiano.
Countertop washbasin.
Lavabo de apoyo.

art. 5412 - 55x35

Bidet sospeso monoforo.
Wall-hung bidet, one hole.
Bidet suspendido 1 orificio.

art. 5411 - 55x35

Vaso sospeso.
Wall-hung wc.
Inodoro suspendido.

art. 1021 - 72x90xh6

Piatto doccia in ceramica con decoro antiscivolo.
Ceramic shower tray with antiskid texture.
Plato de ducha en cerámica con decoración antideslizante.

art. 5418 - 188x88

Vasca in Pietraluce®, senza troppopieno,
installazione free standing.
Pietraluce® bathtub, without overflow.
Free standing installation.
Bañera en Pietraluce®, sin rebosadero.
Instalación free standing.





Lavabo da appoggio soprapiano 50x38 cm.
Countertop washbasin 50x38 cm.
Lavabo de apoyo 50x38 cm.

- art. **5417** bianco/white/blanco
- art. **5417NE** nero/black/negro

Specchiera cm 80x40 con cornice finitura alluminio.
Mirror 80x40 cms with aluminium finishing frame.
Espejo 80x40cm con marco acabado aluminio.

- art. **5437**

Mobile contenitore sospeso, con anta SX-DX, cm 40x20, laccato lucido. Maniglia e schienale in acciaio a specchio.
Wall-hung case cabinet with left-right door, 40x20cms, glossy lacquered. Handle and inside back mirrored steel.
Mueble suspendido, con puerta SX-DX, 40x20cm, lacado brillante, con tirador y esquineros en acero.

- art. **5421** Finitura bianco/white/blanco
- art. **5421NE** Finitura nero/black/negro

Mobile contenitore sospeso a giorno, cm 40x20, laccato lucido. Schienale in acciaio a specchio.
Wall-hung case cabinet 40x20cms, glossy lacquered. Inside back mirrored steel.
Mueble suspendido, 40x20cm, lacado brillante y esquineros en acero.

- art. **5422** Finitura bianco/white/blanco
- art. **5422NE** Finitura nero/black/negro

Mensola in MDF a misura, da cm80 a cm 260, verniciata colore bianco lucido, finitura termoindurente.
MDF wooden shelf, made to measure, from 80cms to 260cms, glossy white varnished, thermosetting finishing.
Repisa a medida en DM, de 80cm a 260cm, lacada en blanco brillante, con acabado termoindurente.

- art. **5434** Finitura bianco/white/blanco
- art. **5434NE** Finitura nero/black/negro

La finitura termoindurente è una vernice trasparente lucida, che essicca a 60°, per circa un'ora: questo procedimento conferisce alla vernice una particolare durezza e resistenza all'abrasione.
The thermosetting finishing is a glossy transparent varnish getting dry at 60° for about 1 hour: this process gives the varnish a special hardness and abrasion-resistance.
El acabado termoindurente es un barniz transparente brillo que seca a 60°, en aproximadamente 1 hora: este procedimiento confiere al barniz una mayor dureza y resistencia a la abrasión.

Mobile sospeso cm163 con due cassetti estraibili laccato lucido, completo di piano in vetro.
Wall-hung box cabinet 163cms, glossy lacquered, 2 removable drawers and glass top.
Mueble contenedor suspendido 163cm, lacado brillante, 2 cajones extraibles y con plancha de vidrio.

- art. **5436** Finitura bianco/white/blanco
- art. **5436NE** Finitura nero/black/negro

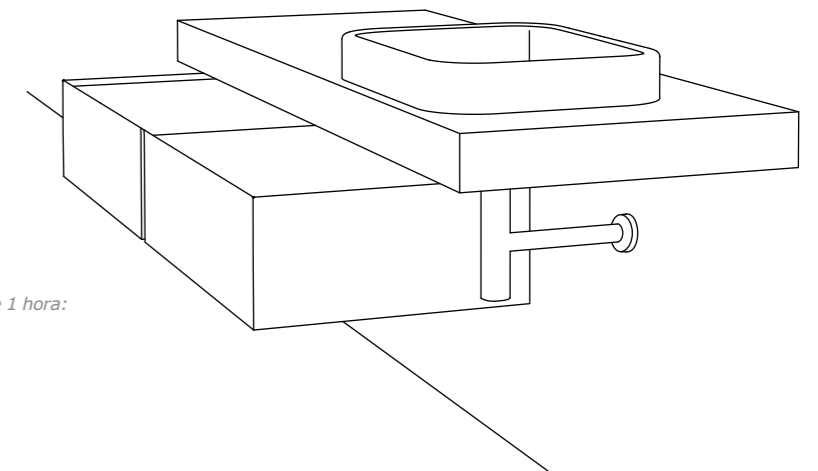
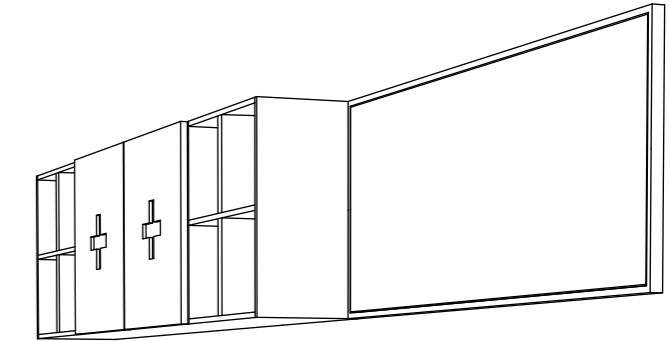
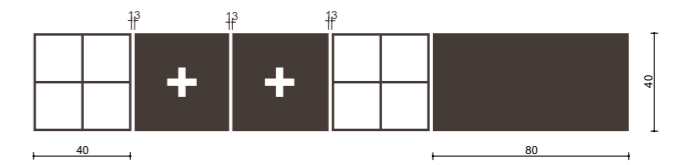



Lavabo da appoggio soprapiano 50x38 cm.
 Countertop washbasin 50x38 cm.
 Lavabo de apoyo 50x38 cm.

□	art. 5417	bianco/white/blanco
■	art. 5417NE	nero/black/negro

Specchiera cm 50x100 con cornice finitura alluminio.
 Mirror 50x100cms with aluminium finishing frame.
 Espejo 50x100cm con marco acabado aluminio

art. **5438**

Mobile sospeso portalavabo Destro, cm75, componibile verso Sinistra, in MDF laccato lucido, con piano in vetro monoforo e ripiano interno, 2 ante. (vedi pag.46-47).
 Right wall-hung MDF wooden cabinet, 75cms, modular on the Left, glossy lacquered, with glass top one hole and internal shelf, 2 doors. (see page 46-47).
 Mueble suspendido DX, ampliable hacia la izquierda, en DM, 75cm, lacado brillante, con plancha de vidrio 1 orificio y repisa interna, 2 puertas. (ver pg.46-47).

art. **5431/5431NE/5431R**

Modulo centrale per composizione, cm40, completo di piano in vetro e ripiano interno, 1 anta, laccato lucido.
 Modular central cabinet, 40cms, with glass top and internal shelf, 1 door, glossy lacquered.
 Modulo central para composición, 40cm, con plancha de vidrio y repisa interna, 1 puerta, lacado brillante.

art. **5433/5433NE/5433R**

Mobile sospeso portalavabo Sinistro, cm75, componibile verso Destra, in MDF laccato lucido, con piano in vetro monoforo e ripiano interno, 2 ante.
 Left wall-hung MDF wooden cabinet, 75cms, modular on the Right, glossy lacquered, with glass top one hole and internal shelf, 2 doors.
 Mueble suspendido SX, ampliable hacia la derecha, en DM, 75cm, lacado brillante, con plancha de vidrio 1 orificio y repisa interna, 2 puertas.

art. **5432/5432NE/5432R**

Lampada in ceramica, 21x11cm.
 Ceramic lamp, 21x11cms.
 Aplique en cerámica, 21x11cm.

art. **5428**

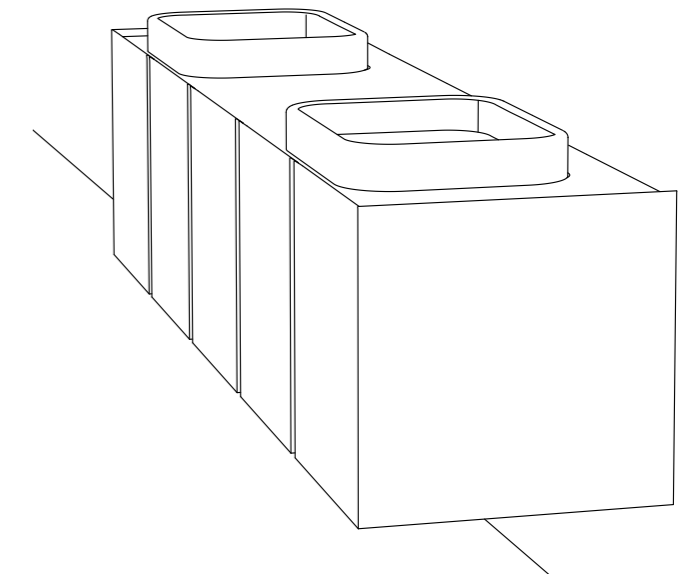
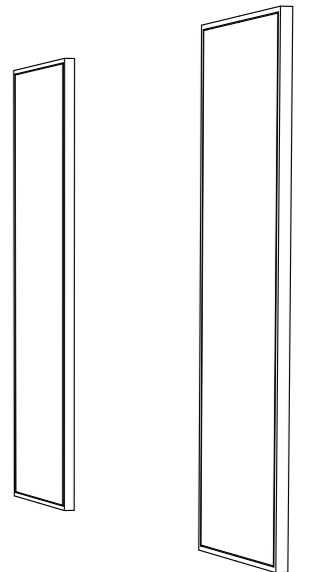
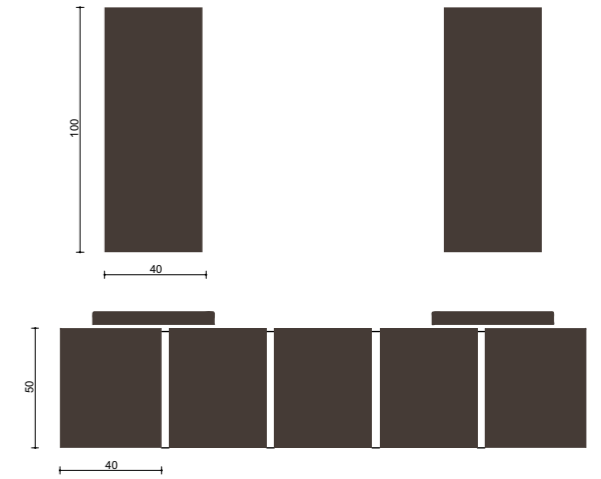



art. 5426
Appendiabito in ceramica.
Ceramic hook.
Percha en cerámica.



art. 5425
Portasciugamani in ceramica.
Ceramic towel rack.
Toallero en cerámica.



art. 5423
Portarotolo in ceramica.
Ceramic toilet roll-holder.
Portarollos en cerámica.



art. 5424
Portasapone per lavabo e bidet in ceramica.
Ceramic soap dish for basin and bidet.
Jabonera para lavabo y bidet.



art. 5427
Portascopino in ceramica.
Ceramic toilet brush-holder.
Escobilla en cerámica.

art. 5428
Lampada in ceramica.
Ceramic lamp.
Aplique en cerámica.



Mobile sospeso portalavabo SX cm 75x52

Mobile - modulo DX cm 40x52

Left wall-hung MDF wooden cabinet, modular on the right, 75x52cms. Right cabinet, modular on the left, 40x52cms. Mueble suspendido SX, ampliable hacia la derecha, en DM, 75x52cm. Modulo DX para componer hacia la izquierda, 40x52cm.

art. 5432
art. 5433DX



Mobile sospeso portalavabo DX cm 75x52

Mobile - modulo SX cm 40x52

Right wall-hung MDF wooden cabinet, modular on the left, 75x52cms. Left cabinet, modular on the right, 40x52cms. Mueble suspendido DX, ampliable hacia la izquierda, en DM, 75x52cm. Modulo SX para componer hacia la derecha, 40x52cm.

art. 5431
art. 5433SX



Mobile sospeso portalavabo SX + DX cm 75x52

Mobile - modulo Centrale cm 40x52

Left + Right wall-hung MDF wooden cabinet, 75x52cms. Modular Central cabinet, 40x52cms. Mueble suspendido SX + DX, en DM, 75x52cm. Modulo Central para composición, 40x52cm.

art. 5432
art. 5431
art. 5433



Mobile sospeso portalavabo DX cm 75x52

Mobile - modulo centrale cm40x52.

Right wall-hung MDF wooden cabinet, modular on the left, 75x52cms. Modular central cabinet. Left cabinet, modular on the right, 40x52cms. Mueble suspendido DX, ampliable hacia la izquierda, en DM, 75x52cm. Modulo central para composición. Modulo SX para componer hacia la derecha, 40x52cm.

art. 5431
art. 5433
art. 5433SX



Mensola in MDF a misura, da cm80 a cm260.

Mobile sospeso cm80 con cassetto estraibile.

MDF wooden shelf, made to measure, from 80cms to 260cms. Wall-hung box cabinet 80cms with removable drawer. Repisa a medida en DM, de 80cm a 260cm. Mueble contenedor suspendido 80cm con cajón extraíble.

art. 5434
art. 5435



Mensola in MDF a misura, da cm80 a cm260.

Mobile sospeso cm163 con 2 cassette estraibili.

MDF wooden shelf, made to measure, from 80cms to 260cms. Wall-hung box cabinet 163cms with 2 removable drawers. Repisa a medida en DM, de 80cm a 260cm. Mueble contenedor suspendido 163cm con 2 cajones extraíbles.

art. 5434
art. 5436





5400M Lavabo sospeso cm85x44, monoforo.
Fissaggio incluso.
Wall-hung washbasin 85x44cms, one hole.
Fixing kit included.
Lavabo suspendido 85x44cm, 1 orificio.
Fijaciones incluidas.

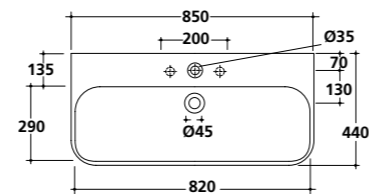

5400 Lavabo sospeso cm85x44, 3 fori.
Fissaggio incluso.
Wall-hung washbasin 85x44cms, 3 holes.
Fixing kit included.
Lavabo suspendido 85x44cm, 3 orificios.
Fijaciones incluidas.

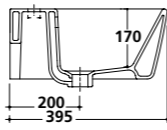

5400SF Lavabo sospeso cm85x44, senza foro.
Fissaggio incluso.
Wall-hung washbasin 85x44cms, without tap hole.
Fixing kit included.
Lavabo suspendido 85x44cm, sin orificio.
Fijaciones incluidas.

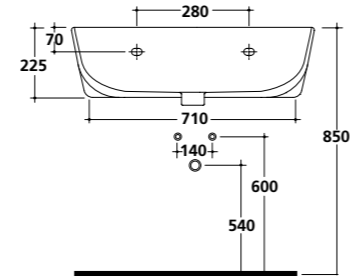

5441 Portasciugamani in ottone cromato cm65.
Chromium-plated brass towel-rack, 65cms.
Toallero en latón cromado, 65cm.



5401M Lavabo sospeso cm75x44, monoforo.
Fissaggio incluso.
Wall-hung washbasin 75x44cms, one hole.
Fixing kit included.
Lavabo suspendido 75x44cm, 1 orificio.
Fijaciones incluidas.

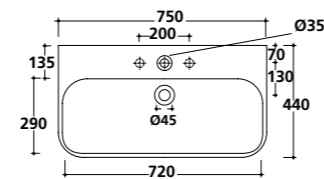

5401 Lavabo sospeso cm75x44, 3 fori.
Fissaggio incluso.
Wall-hung washbasin 75x44cms, 3 holes.
Fixing kit included.
Lavabo suspendido 75x44cm, 3 orificios.
Fijaciones incluidas.

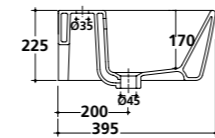

5401SF Lavabo sospeso cm75x44, senza foro.
Fissaggio incluso.
Wall-hung washbasin 75x44cms, without tap hole.
Fixing kit included.
Lavabo suspendido 75x44cm, sin orificio.
Fijaciones incluidas.

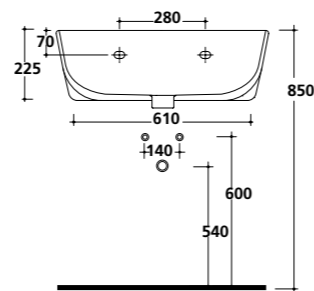

5440 Portasciugamani in ottone cromato cm55.
Chromium-plated brass towel-rack, 55cms.
Toallero en latón cromado, 55cm.



5402M Lavabo sospeso cm65x44, monoforo.
Fissaggio incluso.
Wall-hung washbasin 65x44cms, one hole.
Fixing kit included.
Lavabo suspendido 65x44cm, 1 orificio.
Fijaciones incluidas.

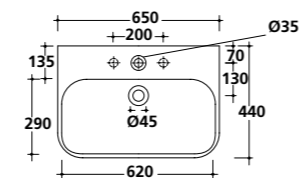

5402 Lavabo sospeso cm65x44, 3 fori.
Fissaggio incluso.
Wall-hung washbasin 65x44cms, 3 holes.
Fixing kit included.
Lavabo suspendido 65x44cm, 3 orificios.
Fijaciones incluidas.

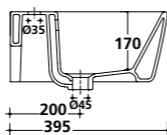

5402SF Lavabo sospeso cm65x44, senza foro.
Fissaggio incluso.
Wall-hung washbasin 65x44cms, without tap hole.
Fixing kit included.
Lavabo suspendido 65x44cm, sin orificio.
Fijaciones incluidas.

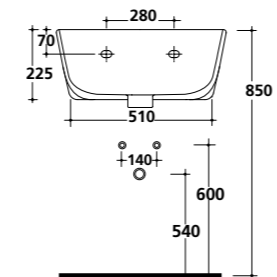

5439 Portasciugamani in ottone cromato cm45.
Chromium-plated brass towel-rack, 45cms.
Toallero en latón cromado, 45cm.



5405P Lavabo Monolite cm 50x40.
Scarico a parete. (Scarico pavimento da specificare). Kit di scarico dell'acqua incluso; kit di fissaggio incluso.
Monolith washbasin 50x40cms. Wall drain (specify if floor drain requested). Fixing kit and trap included.
Monolito lavabo 50x40 cm, descarga a pared. (Descarga a suelo, indicar). Kit de descarga incluido; kit de fijaciones incluido.

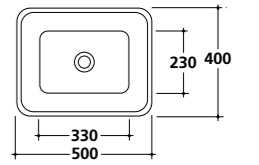

5405PNE Lavabo Monolite cm 50x40, nero.
Scarico a parete. (Scarico pavimento da specificare). Kit di scarico dell'acqua incluso; kit di fissaggio incluso.
Monolith washbasin 50x40cms, black. Wall drain (specify if floor drain requested). Fixing kit and trap included.
Monolito lavabo 50x40 cm, negro. Descarga a pared. (Descarga a suelo, indicar). Kit de descarga incluido; kit de fijaciones incluido.

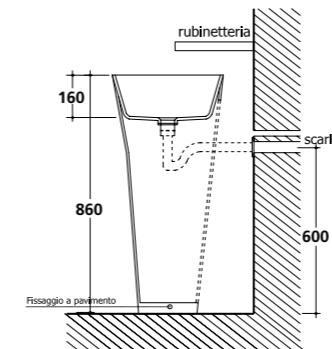

5406P

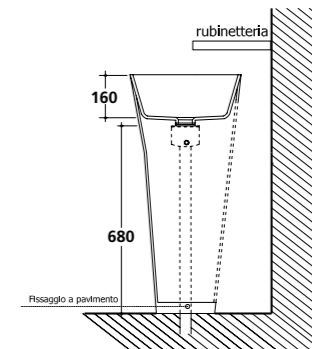
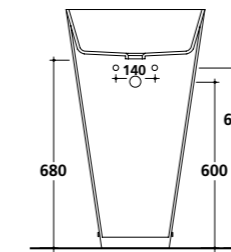

5406S

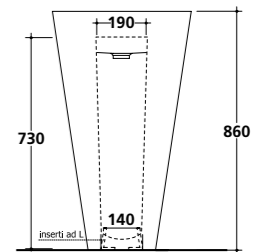

Il lavabo con lo scarico a pavimento non è adatto ad una installazione free standing.
The washbasin with floor drain is not suitable for the free standing installation.
El lavabo con la descarga a suelo no es adecuado para una instalación independiente (libre).



5406P Lavabo Monolite cm 50x40 in legno Iroko.
Predisposto rubinetteria a parete. Scarico a parete, kit di scarico dell'acqua incluso. Kit di fissaggio incluso.
Iroko wooden Monolith washbasin 50x40cms. Arranged for wall tap. Wall drain, fixing kit and trap included.
Monolito lavabo 50x40cm en madera de Iroko. Para grifería a pared. Descarga a pared, kit de descarga incluido.
Kit de fijaciones incluido.

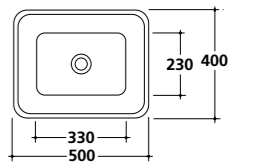

5406S Lavabo Monolite cm 50x40 in legno Iroko.
Predisposto rubinetteria a pavimento. Scarico a suolo, kit di scarico dell'acqua incluso. Installazione free standing.
Iroko wooden Monolith washbasin 50x40cms. Arranged for floor tap. Floor drain, fixing kit and trap included. Free standing.
Monolito lavabo 50x40cm en madera de Iroko. Para grifería a suelo. Descarga a suelo, kit de descarga incluido. Instalación free standing. Kit de fijaciones incluido.

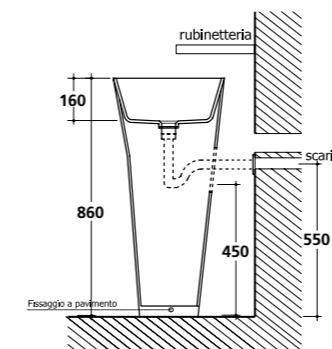
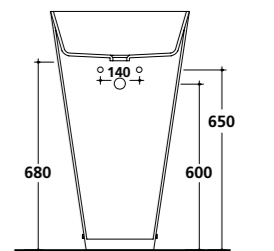

5406P

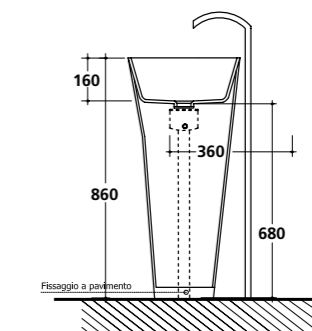
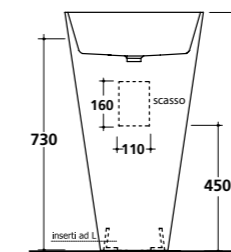

5406S



5404 Lavabo Monolite cm 50, bianco, scarico a parete (scarico pavimento da specificare), completo di mensola monoforo in MDF, verniciata bianco lucido finitura termoindurente. Kit di scarico dell'acqua incluso; kit di fissaggio incluso.
Monolith washbasin 50 cms, white colour, wall drain (specify if floor drain requested), with MDF wooden shelf one hole, glossy white varnished, thermosetting finishing. Fixing kit and trap included.
 Monolito lavabo 50 cm, bianco, descarga a pared (descarga a suelo, indicar), con repisa 1 orificio en DM, barnizada blanco brillo, acabado termoindurente. Kit de descarga incluido; kit de fijaciones incluido.

5404NE Lavabo Monolite cm 50, nero, scarico a parete (scarico pavimento da specificare), completo di mensola monoforo in MDF, verniciata bianco lucido finitura termoindurente. Kit di scarico dell'acqua incluso; kit di fissaggio incluso.
Monolith washbasin 50 cms, black colour, wall drain (specify if floor drain requested), with MDF wooden shelf one hole, glossy white varnished, thermosetting finishing. Fixing kit and trap included.
 Monolito lavabo 50 cm, negro, descarga a pared (descarga a suelo, indicar), con repisa 1 orificio en DM, barnizada blanco brillo, acabado termoindurente. Kit de descarga incluido; kit de fijaciones incluido.

5404R Lavabo Monolite bianco cm 50 scarico a parete (scarico pavimento da specificare), completo di mensola monoforo in MDF, verniciata lucido finitura termoindurente, RAL a richiesta. Kit di scarico dell'acqua incluso; kit di fissaggio incluso.
Monolith washbasin 50 cms, wall drain (specify if floor drain requested), with MDF wooden shelf one hole, glossy varnished, thermosetting finishing, RAL on request. Fixing kit and trap included.
 Monolito lavabo 50 cm, descarga a pared (descarga a suelo, indicar), con repisa 1 orificio en DM, barnizada brillo, acabado termoindurente, RAL a petición. Kit de descarga incluido; kit de fijaciones incluido.

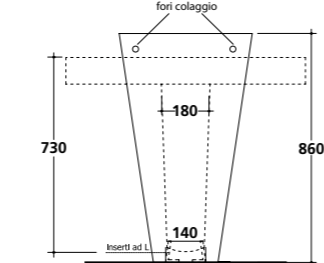
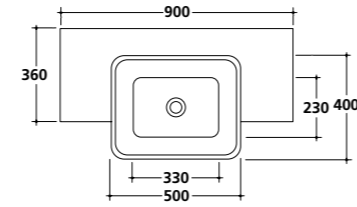
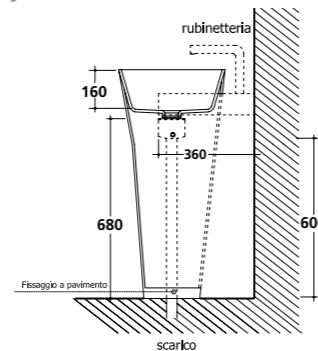
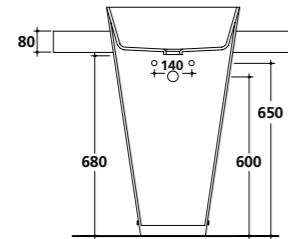
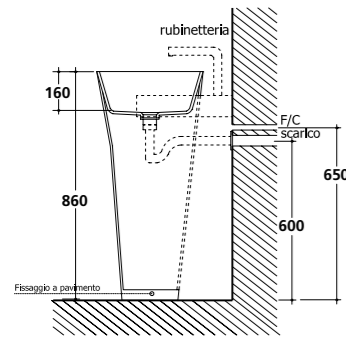

5407M Lavabo sospeso cm45x40, monoforo. Fissaggio incluso.
Wall-hung washbasin 45x40cms, one hole. Fixing kit included.
 Lavabo suspendido 45x40cm, 1 orificio. Fijaciones incluidas.

5407SF Lavabo sospeso cm45x40, senza foro. Fissaggio incluso.
Wall-hung washbasin 45x40cms, without tap hole. Fixing kit included.
 Lavabo suspendido 45x40cm, sin orificio. Fijaciones incluidas.

5407NE Lavabo sospeso cm45x40, monoforo, nero. Fissaggio incluso.
Wall-hung washbasin 45x40cms, one hole, black. Fixing kit included.
 Lavabo suspendido 45x40cm, 1 orificio, negro. Fijaciones incluidas.

5407SNE Lavabo sospeso cm45x40, senza foro, nero. Fissaggio incluso.
Wall-hung washbasin 45x40cms, without tap hole, black. Fixing kit included.
 Lavabo suspendido 45x40cm, sin orificio, negro. Fijaciones incluidas.

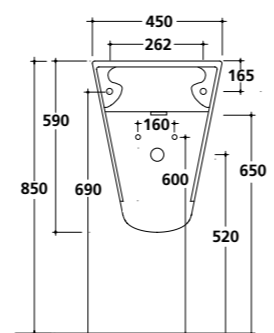
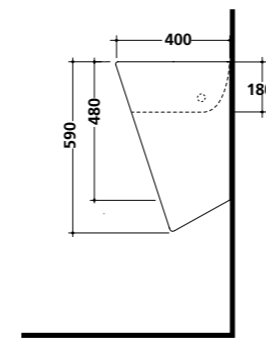
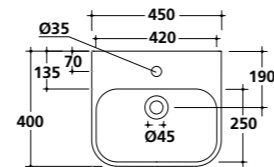

Disponibile da Marzo 2011
 Available from March 2011
 Disponible desde Marzo 2011



5403 Lavabo-lavatoio cm65x45. Rubinetteria a parete Fissaggio incluso.
Wall-hung washbasin-washtub 65x45cms, wall tap. Fixing kit included.
 Lavabo-lavadero 65x45cm, grifería a pared. Fijaciones incluidas.

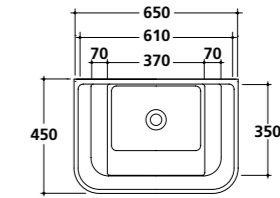

5442 Asse in legno di frassino per lavabo art. 5403.
Ash wooden board for washbasin art. 5403.
 Tabla en madera de fresno para lavabo art. 5403.

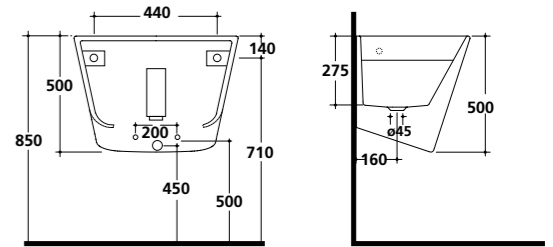

5417 Lavabo da appoggio soprapiano cm 50x38. Per rubinetteria a parete o su piano.
Countertop washbasin 50x38cms. Arranged for wall tap or on a counter.
 Lavabo de apoyo 50x38cm. Para grifería a pared o sobre encimera.

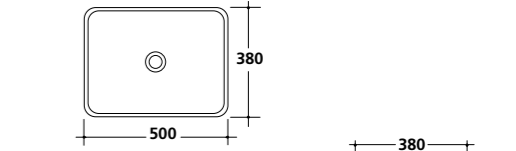

5417NE Lavabo da appoggio cm 50x38, nero. Per rubinetteria a parete o su piano.
Countertop washbasin 50x38cms, black. Arranged for wall tap or on a counter.
 Lavabo de apoyo 50x38cm, negro. Para grifería a pared o sobre encimera.

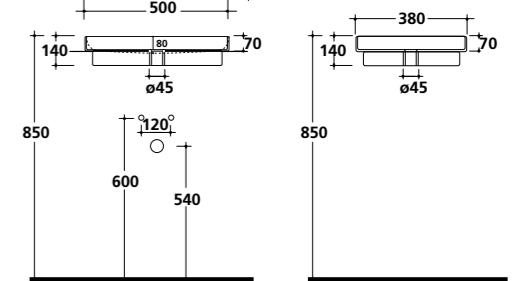

5420 Mensola in MDF da cm 80, verniciata colore bianco lucido finitura termoindurente.
MDF wooden shelf 80cms, glossy white varnished, thermosetting finishing.
 Repisa en DM, de 80cm, barnizada en color blanco brillo acabado termoindurente.

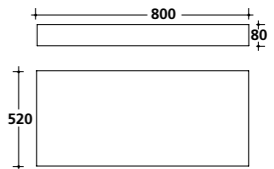

5420NE Mensola in MDF da cm 80, verniciata colore nero lucido finitura termoindurente.
MDF wooden shelf 80cms, glossy black varnished, thermosetting finishing.
 Repisa en DM, de 80cm, barnizada en color negro brillo acabado termoindurente.



La finitura termoindurente è una vernice trasparente lucida, che essicca a 60°, per circa un'ora: questo procedimento conferisce alla vernice una particolare durezza e resistenza all'abrasione.
The thermosetting finishing is a glossy transparent varnish getting dry at 60° for about 1 hour: this process gives the varnish a special hardness and abrasion-resistance.
 El acabado termoindurente es un barniz transparente brillo que seca a 60°, en aproximadamente 1 hora: este procedimiento confiere al barniz una mayor durezza y resistencia a la abrasión.

5430 Mobile sospeso portalavabo, cm75, in MDF laccato lucido bianco, con piano in vetro monoforo e ripiano interno, 2 ante, per art. 5417/NE.
Wall-hung MDF wooden cabinet 75cms for basin art. 5417/NE, glossy white lacquered, with glass top one hole and internal shelf, 2 doors.
 Mueble suspendido en DM, lacado blanco brillante, 75cm, con plancha de vidrio 1 orificio y repisa interna, 2 puertas, para lavabo art. 5417/NE.

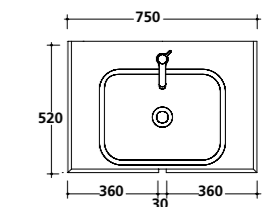

5430NE Mobile sospeso portalavabo, cm75, in MDF laccato lucido nero, con piano in vetro monoforo e ripiano interno, 2 ante, per art. 5417/NE.
Wall-hung MDF wooden cabinet 75cms for basin art. 5417/NE, glossy black lacquered, with glass top one hole and internal shelf, 2 doors.
 Mueble suspendido en DM, lacado negro brillante, 75cm, con plancha de vidrio 1 orificio y repisa interna, 2 puertas, para lavabo art. 5417/NE.

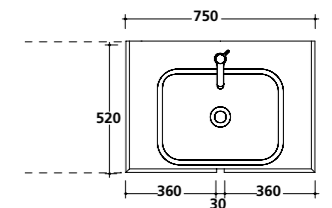

5430R Mobile sospeso portalavabo, cm75, in MDF laccato lucido RAL a richiesta, con piano in vetro monoforo e ripiano interno, 2 ante, per art. 5417/NE.
Wall-hung MDF wooden cabinet 75cms for basin art. 5417/NE, RAL colour on request, glossy lacquered, with glass top one hole and internal shelf, 2 doors.
 Mueble suspendido en DM, lacado brillante RAL a petición, plancha de vidrio 1 orificio y repisa interna, 2 puertas, para art. 5417/NE.



5412 Bidet sospeso monoforo.
Wall-hung bidet, one hole.
Bidet suspendido 1 orificio.

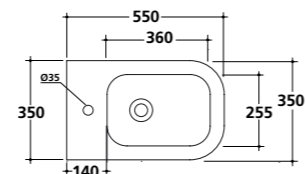

5412NE Bidet sospeso monoforo, nero.
Wall-hung bidet, one hole, black.
Bidet suspendido 1 orificio, negro.

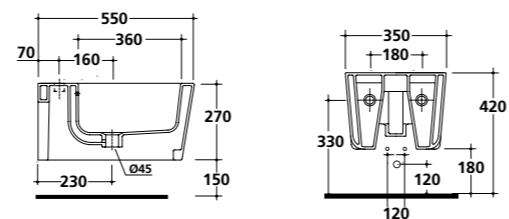

5410 Bidet monoforo. Fissaggio incluso.
One hole bidet. Fixing kit included.
Bidet 1 orificio. Fijaciones incluidas.

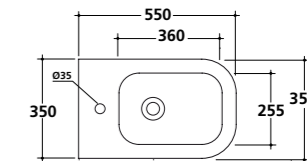

5410NE Bidet monoforo, nero. Fissaggio incluso.
One hole bidet, black. Fixing kit included.
Bidet 1 orificio, negro. Fijaciones incluidas.

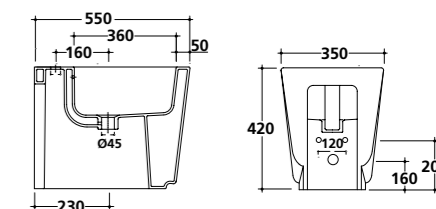

5411 Vaso sospeso.
Wall-hung w.c.
Inodoro suspendido.

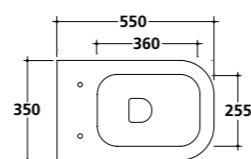

5411NE Vaso sospeso, nero.
Wall-hung w.c., black.
Inodoro suspendido, negro.



5415 Coprivaso avvolgente in termoindurente.
Thermosetting wrap around seat-cover.
Tapa inodoro envolvente termoindurente.

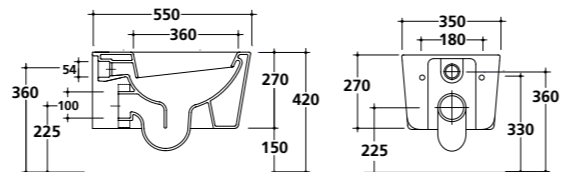

5416 Coprivaso avvolgente in termoindurente, cerniera con dispositivo di caduta rallentata.
Thermosetting wrap around seat-cover with soft closing system.
Tapa termoindurente con bisagra de caída amortiguada.

5415NE Coprivaso avvolgente in termoindurente, nero.
Thermosetting wrap around seat-cover, black.
Tapa inodoro envolvente termoindurente, negro.



5409 Vaso con scarico universale "S/P, trasformabile tramite curva tecnica. Fissaggio incluso.
W.c. with floor/wall draining, adjustable by elbow/wall pipe. Fixing kit included.
Inodoro para tanque alto salida horizontal ó vertical. Transformable por medio del sifón de evacuación. Fijaciones incluidas.

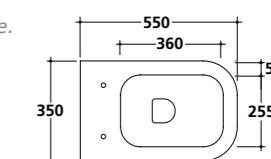

5409NE Vaso con scarico universale "S/P, trasformabile tramite curva tecnica, nero. Fissaggio incluso.
W.c. with floor/wall draining, adjustable by elbow/wall pipe, black. Fixing kit included.
Inodoro para tanque alto salida horizontal ó vertical. Transformable por medio del sifón de evacuación, negro. Fijaciones incluidas.

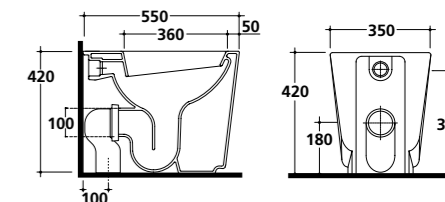

5415 Coprivaso avvolgente in termoindurente.
Thermosetting wrap around seat-cover.
Tapa inodoro envolvente termoindurente.

5416 Coprivaso avvolgente in termoindurente, cerniera con dispositivo di caduta rallentata.
Thermosetting wrap around seat-cover with soft closing system.
Tapa termoindurente con bisagra de caída amortiguada.



5415NE Coprivaso avvolgente in termoindurente, nero.
Thermosetting wrap around seat-cover, black.
Tapa inodoro envolvente termoindurente, negro.

Disponibile da Aprile 2011
Available from April 2011
Disponibile desde Abril 2011

5408 Orinatoio sospeso.
Wall mounted urinal.
Urinario suspendido.

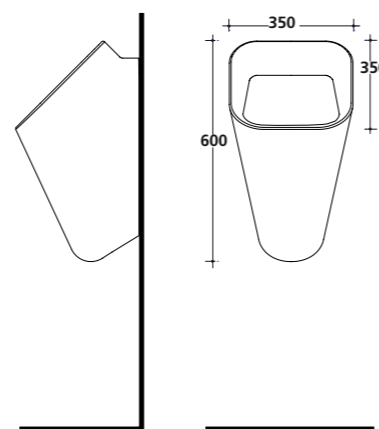

Disponibile da Marzo 2011
Available from March 2011
Disponible desde Marzo 2011



5413 Vaso monoblocco con scarico universale "S/P", trasformabile tramite curva tecnica. Fissaggio incluso.
Close-coupled toilet, back to wall with wall/floor draining.
Adjustable by elbow/wall pipe. Fixing kit included.
Inodoro tanque bajo salida horizontal ó vertical.
Transformable por medio del sifón de evacuación.
Fijaciones incluidas.

5413NE Vaso monoblocco con scarico universale "S/P", trasformabile tramite curva tecnica, nero. Fissaggio incluso.
Close-coupled toilet, back to wall with wall/floor draining.
Adjustable by elbow/wall pipe, black. Fixing kit included.
Inodoro tanque bajo salida horizontal ó vertical.
Transformable por medio del sifón de evacuación, negro.
Fijaciones incluidas.

5414 Cassetta in ceramica per vaso monoblocco.
Ceramic cistern for close-coupled toilet.
Tanque cerámico para inodoro.

5414NE Cassetta in ceramica per vaso monoblocco, nero.
Ceramic cistern for close-coupled toilet, black.
Tanque cerámico para inodoro, negro.

Da combinarsi con art. 9045
To be combined with art. 9045
Para combinar con art. 9045

9045 Cassetta in plastica anticondensa sistema doppio flusso.
Anticondensation plastic cistern double flow system.
Depósito plástico anticondensación con mecanismo doble descarga.

5415 Coprivaso avvolgente in termoindurente.
Thermosetting wrap around seat-cover.
Tapa inodoro envolvente termoindurente.

5416 Coprivaso avvolgente in termoindurente, cerniera con dispositivo di caduta rallentata.
Thermosetting wrap around seat-cover with soft closing system.
Tapa termoindurente con bisagra de caída amortiguada.

5415NE Coprivaso avvolgente in termoindurente, nero.
Thermosetting wrap around seat-cover, black.
Tapa inodoro envolvente termoindurente, negro.

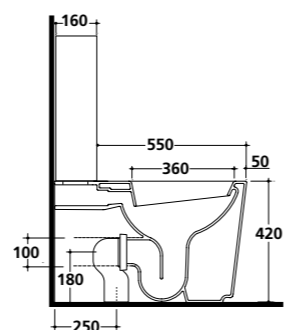
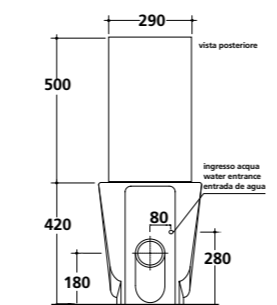
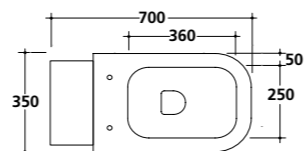

5418 Vasca in Pietraluce® cm188x88, senza troppopieno. Bianco. Installazione free standing. Completa di kit di fissaggio e sistema di scarico con piletta up-down.
Pietraluce® bathtub 188x88cms, without overflow. White colour. Free standing installation. Fixing kit and up-down drain included.
Bañera en Pietraluce®, 188x88cm, sin rebosadero. Color blanco. Instalación free standing y sistema de desagüe con válvula up-down.

5418NE Vasca in Pietraluce® cm188x88, senza troppopieno. Nero. Installazione free standing. Completa di kit di fissaggio e sistema di scarico con piletta up-down.
Pietraluce® bathtub 188x88cms, without overflow. Black colour. Free standing installation. Fixing kit and up-down drain included.
Bañera en Pietraluce®, 188x88cm, sin rebosadero. Color Negro. Instalación free standing y sistema de desagüe con válvula up-down.

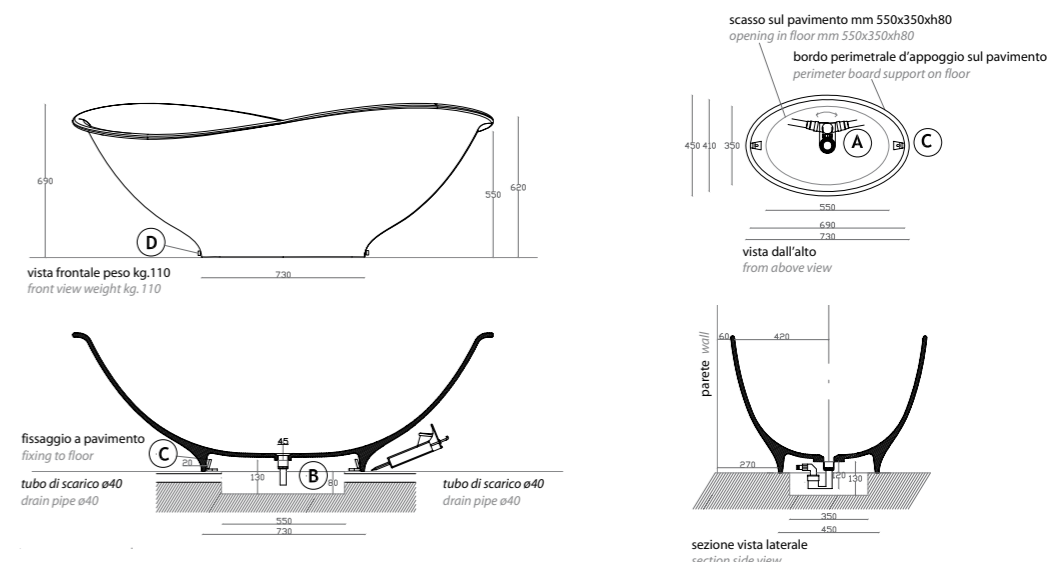

vista frontale peso kg.110
front view weight kg.110

vista dall'alto
from above view

fissaggio a pavimento
fixing to floor

sezione vista laterale
section side view

SCHEDA TECNICA MATERIALE PIETRALUCE®

Pietraluce® è un composto di allumina idrata, biossido di titanio e resina poliestere.

- 1) Resistenza all'abrasione (NEMA LD 3-1975): è superiore a 2000 cicli.
- 2) Resistenza all'alta temperatura (NEMA LD 3-1975): il recipiente, contenente cera fusa a 180°C, provoca leggere variazioni del colore sulla superficie.
- 3) Resistenza alla macchia (ANSI Z 124.1-1974).
- 4) Resistenza chimica (ANSI Z 124.1 - 1974): dopo 14 ore non lasciano segni visibili: alcool etilico, acido citrico 10%, urea 6,6%, acqua ossigenata 3%, ipoclorito e acetone. La benzina super lascia un'impronta visibile se non è asportata entro 20 minuti.
- 5) Resistenza al lavaggio (ASTM D 2486):
- 6) Resistenza all'invecchiamento artificiale.
- 7) Resistenza alla scalfittura: il carico necessario con "Taber" con punta di diamante è 190g.
- 8) Resistenza all'infiammabilità (ASTM D 635).

TECHNICAL SHEET MATERIAL PIETRALUCE®

Pietraluce® is a compound of hydrated alumina, titanium dioxide and polyester resin.

- 1) Abrasion resistance (NEMA LD 3-1975): is above 2000 cycles.
- 2) High temperature resistance (NEMA LD 3-1975): the container, containing molten wax at 180°C, causes slight colour variations on the surface.
- 3) Staining resistance (ANSI Z 124.1-1974).
- 4) Chemical resistance (ANSI Z 124.1-1974): after a lapse of 14 hrs, the following chemicals do not leave any visible sign: ethyl alcohol, 10% citric acid, 6,6% urea, 3% hydrogen peroxide, hypochlorite and acetone. The high octane gasoline leaves a visible trace unless it is removed within 20 minutes.
- 5) Resistance to washing (ASTM D 2486).
- 6) Resistance to accelerated ageing.
- 7) Scratch resistance: the charge requested for scratching with "Taber" with diamond point is 190 g.
- 8) Inflammability resistance (ASTM D 635).

HOJA DE CARACTERÍSTICAS TÉCNICAS DEL MATERIAL PIETRALUCE®

Pietraluce® es una mezcla de alúmina hidratada, bióxido de titanio y resina de poliéster.

- 1) Resistencia a la abrasión (NEMA LD 3 hasta 1975): más de 2000 ciclos.
- 2) Resistencia a altas temperaturas (NEMA LD 3 a 1975): el recipiente contiene cera fundida a 180° C, que provoca ligeras variaciones de color en la superficie.
- 3) Resistencia a las manchas (ANSI Z 124.1 a 1.974).
- 4) Resistencia química (ANSI Z 124,1 a 1974): después de 14 horas no dejan signos visibles: el alcohol etílico, 10% de ácido cítrico, urea 6,6%, 3% de agua oxigenada, hipoclorito y acetona. La gasolina deja una impronta visible si no se elimina durante los primeros 20 minutos.
- 5) La resistencia de lavado (ASTM D 2486).
- 6) Resistencia al envejecimiento artificial.
- 7) La resistencia a los arañazos; la carga requerida por "Taber" con el diamante es de 190g.
- 8) Resistencia a la inflamabilidad (ASTM D 635).



5430 Mobile sospeso portlavabo, cm75, in MDF laccato lucido bianco, con piano in vetro monoforo e ripiano interno, 2 ante, per art. 5417/NE.

*Wall-hung MDF wooden cabinet 75cms for basin art. 5417/NE, glossy white lacquered, with glass top one hole and internal shelf, 2 doors.
Mueble suspendido en DM, lacado blanco brillante, 75cm, con plancha de vidrio 1 orificio y repisa interna, 2 puertas, para lavabo art. 5417/NE.*

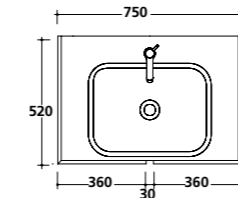

5430NE Mobile sospeso portlavabo, cm75, in MDF laccato lucido nero, con piano in vetro monoforo e ripiano interno, 2 ante, per art. 5417/NE.

*Wall-hung MDF wooden cabinet 75cms for basin art. 5417/NE, glossy black lacquered, with glass top one hole and internal shelf, 2 doors.
Mueble suspendido en DM, lacado negro brillante, 75cm, con plancha de vidrio 1 orificio y repisa interna, 2 puertas, para lavabo art. 5417/NE.*

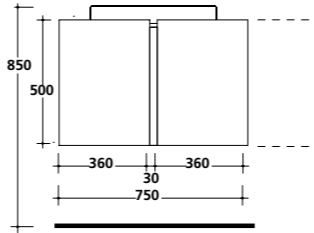

5430R Mobile sospeso portlavabo, cm75, in MDF laccato lucido RAL a richiesta, con piano in vetro monoforo e ripiano interno, 2 ante, per art. 5417/NE.

*Wall-hung MDF wooden cabinet 75cms for basin art. 5417/NE, RAL colour on request, glossy lacquered, with glass top one hole and internal shelf, 2 doors.
Mueble suspendido en DM, lacado brillante RAL a petición, plancha de vidrio 1 orificio y repisa interna, 2 puertas, para art. 5417/NE.*

5431 Mobile sospeso portlavabo **DX**, componibile verso sx, in MDF laccato lucido bianco, con piano in vetro monoforo e ripiano interno, per art. 5417/NE.

*Right wall-hung MDF wooden cabinet for art. 5417/NE, modular on the left, glossy white lacquered, with glass top one hole and internal shelf.
Mueble suspendido DX, ampliable hacia la izquierda, en DM, lacado blanco brillante, con plancha de vidrio 1 orificio y repisa interna para lavabo art. 5417/NE.*

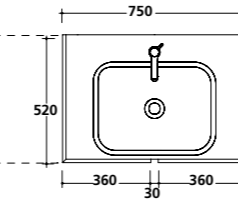

5431NE Mobile sospeso portlavabo **DX**, componibile verso sx, in MDF laccato lucido nero, con piano in vetro monoforo e ripiano interno, per art. 5417/NE.

*Right wall-hung MDF wooden cabinet for art. 5417/NE, modular on the left, glossy black lacquered, with glass top one hole and internal shelf.
Mueble suspendido DX, ampliable hacia la izquierda, en DM, lacado negro brillante, con plancha de vidrio 1 orificio y repisa interna para lavabo art. 5417/NE.*

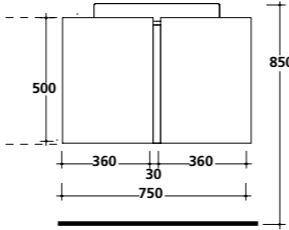

5431R Mobile sospeso portlavabo **DX**, componibile verso sx, in MDF laccato lucido RAL a richiesta, con piano in vetro monoforo e ripiano interno, per art. 5417/NE.

*Right wall-hung MDF wooden cabinet for art. 5417/NE, modular on the left, RAL colour on request, glossy lacquered, with glass top one hole and internal shelf.
Mueble suspendido DX, ampliable hacia la izquierda, en DM, lacado brillante RAL a petición, con plancha de vidrio 1 orificio y repisa interna para art. 5417/NE.*

5432 Mobile sospeso portlavabo **SX**, componibile verso dx, in MDF laccato lucido bianco, con piano in vetro monoforo e ripiano interno, per art. 5417/NE.

*Left wall-hung MDF wooden cabinet for art. 5417/NE, modular on the right, glossy white lacquered, with glass top one hole and internal shelf.
Mueble suspendido SX, ampliable hacia la derecha, en DM, lacado blanco brillante, con repisa en vidrio, con plancha de vidrio 1 orificio y repisa interna para lavabo art. 5417/NE.*

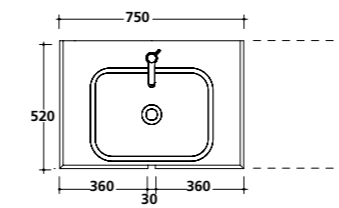

5432NE Mobile sospeso portlavabo **SX**, componibile verso dx, in MDF laccato lucido nero, con piano in vetro monoforo e ripiano interno, per art. 5417/NE.

*Left wall-hung MDF wooden cabinet for art. 5417/NE, modular on the right, glossy black lacquered, with glass top one hole and internal shelf.
Mueble suspendido SX, ampliable hacia la derecha, en DM, lacado negro brillante, con plancha de vidrio 1 orificio y repisa interna para lavabo art. 5417/NE.*

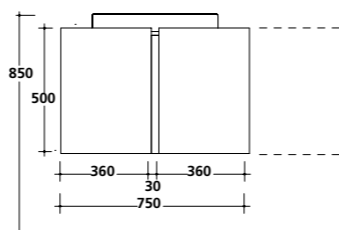

5432R Mobile sospeso portlavabo **SX**, componibile verso dx, in MDF laccato lucido RAL a richiesta, con piano in vetro monoforo e ripiano interno, per art. 5417/NE.

*Left wall-hung MDF wooden cabinet for art. 5417/NE, modular on the right, RAL colour on request, glossy lacquered, with glass top one hole and internal shelf.
Mueble suspendido SX, ampliable hacia la derecha, en DM, lacado brillante en color RAL a petición, con plancha de vidrio 1 orificio y repisa interna para lavabo art. 5417/NE.*



5433 • Modulo Centrale per composizione, cm40, completo di piano in vetro e ripiano interno, 1 anta, laccato lucido bianco.

*Modular central cabinet, 40cms with glass top and internal shelf, 1 door, glossy white lacquered.
Modulo Central para composición, 40cm, con plancha de vidrio y repisa interna, 1 puerta, lacado blanco brillante.*

5433NE • Modulo Centrale per composizione, cm40, completo di piano in vetro e ripiano interno, 1 anta, laccato lucido nero.

*Modular central cabinet, 40cms with glass top and internal shelf, 1 door, glossy black lacquered.
Modulo Central para composición, 40cm, con plancha de vidrio y repisa interna, 1 puerta, lacado negro brillante.*

5433R • Modulo Centrale per composizione, cm40, completo di piano in vetro e ripiano interno, 1 anta, laccato lucido RAL a richiesta.

*Modular central cabinet, 40cms with glass top and internal shelf, 1 door, RAL colour on request, glossy lacquered.
Modulo Central para composición, 40cm, con plancha de vidrio y repisa interna, 1 puerta, lacado brillante en RAL a petición.*

• Specificare nell'ordine l'apertura DX o SX dell'anta.

*When placing the order, specify the door opening: right or left.
Especificar nel pedido la apertura de la puerta DX o SX.*

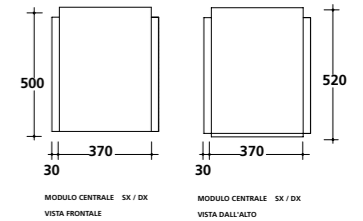

5433DX Modulo Destro per composizione verso sinistra, cm40, completo di piano in vetro e ripiano interno, 1 anta, laccato lucido bianco.

*Right cabinet modular on the left, 40cms, with glass top and internal shelf, 1 door, glossy white lacquered.
Modulo DX, para componer hacia la izquierda, 40cm, con plancha de vidrio y repisa interna, 1 puerta, lacado blanco brillante.*

5433DXNE Modulo Destro per composizione verso sinistra, cm40, completo di piano in vetro e ripiano interno, 1 anta, laccato lucido nero.

*Right cabinet modular on the left, 40cms, with glass top and internal shelf, 1 door, glossy black lacquered.
Modulo DX, para componer hacia la izquierda, 40cm, con plancha de vidrio y repisa interna, 1 puerta, lacado negro brillante.*

5433DXR Modulo Destro per composizione verso sinistra, cm40, completo di piano in vetro e ripiano interno, 1 anta, laccato lucido RAL a richiesta.

*Right cabinet modular on the left, 40cms, with glass top and internal shelf, 1 door, RAL colour on request, glossy lacquered.
Modulo DX, para componer hacia la izquierda, 40cm, con plancha de vidrio y repisa interna, 1 puerta, lacado brillante en RAL a petición.*

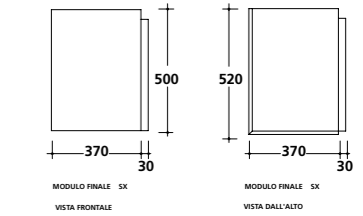

5433SX Modulo Sinistro per composizione verso destra, cm40, completo di piano in vetro e ripiano interno, 1 anta, laccato lucido bianco.

*Left cabinet modular on the right, 40cms, with glass top and internal shelf, 1 door, glossy white lacquered.
Modulo SX, para componer hacia la derecha, 40cm, con plancha de vidrio y repisa interna, 1 puerta, lacado blanco.*

5433SXNE Modulo Sinistro per composizione verso destra, cm40, completo di piano in vetro e ripiano interno, 1 anta, laccato lucido nero.

*Left cabinet modular on the right, 40cms, with glass top and internal shelf, 1 door, glossy black lacquered.
Modulo SX, para componer hacia la derecha, 40cm, con plancha de vidrio y repisa interna, 1 puerta, lacado negro.*

5433SXR Modulo Sinistro per composizione verso destra, cm40, completo di piano in vetro e ripiano interno, 1 anta, laccato lucido RAL a richiesta.

*Left cabinet modular on the right, 40cms, with glass top and internal shelf, 1 door, RAL colour on request, glossy lacquered.
Modulo SX, para componer hacia la derecha, 40cm, con plancha de vidrio y repisa interna, 1 puerta, lacado en RAL a petición.*

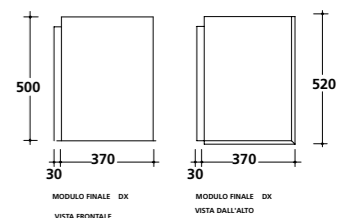



5434 **Mensola** in MDF a misura, da cm80 a cm 260, verniciata colore bianco lucido, finitura termoindurente.
MDF wooden shelf, made to measure, from 80cms to 260cms, glossy white varnished, thermosetting finishing.
Repisa a medida en DM, de 80cm a 260cm, lacada en blanco brillante, con acabado termoindurente.

5434NE **Mensola** in MDF a misura, da cm80 a cm 260, verniciata colore nero lucido, finitura termoindurente.
MDF wooden shelf, made to measure, from 80cms to 260cms, glossy black varnished, thermosetting finishing.
Repisa a medida en DM, de 80cm a 260cm, lacada en negro brillante, con acabado termoindurente.

La finitura termoindurente è una vernice trasparente lucida, che essicca a 60°, per circa un'ora: questo procedimento conferisce alla vernice una particolare durezza e resistenza all'abrasione.
The thermosetting finishing is a glossy transparent varnish getting dry at 60° for about 1 hour: this process gives the varnish a special hardness and abrasion-resistance.
El acabado termoindurente es un barniz transparente brillo que seca a 60°, en aproximadamente 1 hora: este procedimiento confiere al barniz una mayor dureza y resistencia a la abrasión.

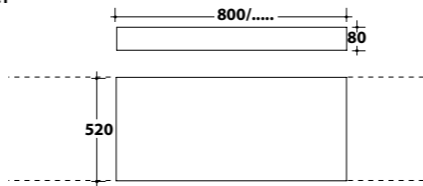

5435 **Mobile sospeso cm80 con cassetto estraibile**, laccato lucido bianco, completo di piano in vetro.
Wall-hung box cabinet 80cms, glossy white lacquered, with removable drawer and glass top.
Mueble contenedor suspendido 80cm, lacado blanco brillante, con cajón extraíble y con plancha de vidrio.

5435NE **Mobile sospeso cm80 con cassetto estraibile**, laccato lucido nero, completo di piano in vetro.
Wall-hung box cabinet 80cms, glossy black lacquered, with removable drawer and glass top.
Mueble contenedor suspendido 80cm, lacado negro brillante, con cajón extraíble y con plancha de vidrio.

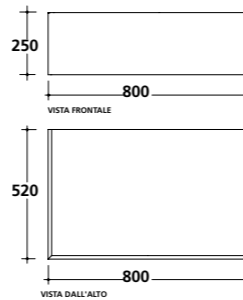

5436 **Mobile sospeso cm163 con 2 cassetti estraibili**, laccato lucido bianco, completo di piano in vetro.
Wall-hung box cabinet 163cms, glossy white lacquered, with 2 removable drawers and glass top.
Mueble contenedor suspendido 163cm, lacado blanco brillante, con 2 cajones extraíbles y con plancha de vidrio.

5436NE **Mobile sospeso cm163 con 2 cassetti estraibili**, laccato lucido nero, completo di piano in vetro.
Wall-hung box cabinet 163cms, glossy black lacquered, with 2 removable drawers and glass top.
Mueble contenedor suspendido 163cm, lacado negro brillante, con 2 cajones extraíbles y con plancha de vidrio.

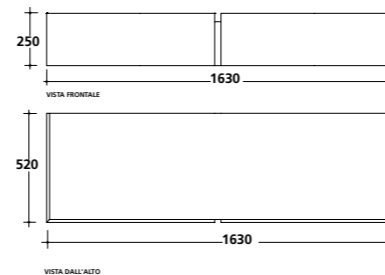

5421 **Mobile contenitore sospeso**, con anta SX-DX, cm 40x20, laccato lucido bianco. Maniglia e schienale in acciaio a specchio.
Wall-hung case cabinet with left-right door, 40x20cms, glossy white lacquered. Handle and inside back mirrored steel.
Mueble suspendido, con puerta SX-DX, 40x20cm, lacado blanco brillante, con tirador y esquineros en acero.

5421NE **Mobile contenitore sospeso**, con anta SX-DX, cm 40x20, laccato lucido nero. Maniglia e schienale in acciaio a specchio.
Wall-hung case cabinet with left-right door, 40x20cms, glossy black lacquered. Handle and inside back mirrored steel.
Mueble suspendido, con puerta SX-DX, 40x20cm, lacado negro brillante, con tirador y esquineros en acero.

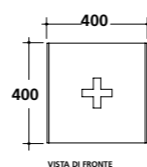
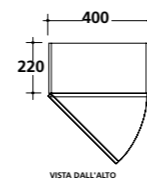

5422 **Mobile contenitore sospeso**, cm 40x20, laccato lucido bianco. Schienale in acciaio a specchio.
Wall-hung case cabinet 40x20cms, glossy white lacquered. Inside back mirrored steel.
Mueble suspendido, 40x20cm, lacado blanco brillante y esquineros en acero.

5422NE **Mobile contenitore sospeso**, cm 40x20, laccato lucido nero. Schienale in acciaio a specchio.
Wall-hung case cabinet 40x20cms, glossy black lacquered. Inside back mirrored steel.
Mueble suspendido, 40x20cm, lacado negro brillante y esquineros en acero.

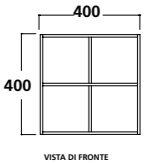
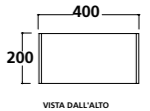

5437 **Specchiera cm80x40** con cornice finitura alluminio per installazione verticale/orizzontale. Senza interruttore e presa.
Mirror 80x40cms with aluminium finishing frame, for vertical or horizontal installation, without switch and socket.
Espejo 80x40cm con marco acabado aluminio para la instalación vertical y horizontal. Sin interruptor y clema.

5438 **Specchiera cm50x100** con cornice finitura alluminio per installazione verticale/orizzontale. Senza interruttore e presa.
Mirror 50x100cms with aluminium finishing frame, for vertical or horizontal installation, without switch and socket.
Espejo 50x100cm con marco acabado aluminio para la instalación vertical y horizontal. Sin interruptor y clema.

6056 **Specchio cm90x100** con cornice finitura alluminio per installazione verticale/orizzontale. Senza interruttore e presa.
Mirror 90x100 cms with aluminium finishing frame, for vertical or horizontal installation, without switch and socket.
Espejo 90x100 con marco acabado aluminio para la instalación vertical y horizontal. Sin interruptor y clema.

6055 **Specchio cm60x100** con cornice finitura alluminio per installazione verticale/orizzontale. Senza interruttore e presa.
Mirror 60x100 cms with aluminium finishing frame, for vertical or horizontal installation, without switch and socket.
Espejo 60x100 con marco acabado aluminio para la instalación vertical y horizontal. Sin interruptor y clema.

6054 **Specchio cm40x100** con cornice finitura alluminio per installazione verticale/orizzontale. Senza interruttore e presa.
Mirror 40x100 cms with aluminium finishing frame, for vertical or horizontal installation, without switch and socket.
Espejo 40x100 con marco acabado aluminio para la instalación vertical y horizontal. Sin interruptor y clema.

6053 **Specchio cm30x100** con cornice finitura alluminio per installazione verticale/orizzontale. Senza interruttore e presa.
Mirror 30x100 cms with aluminium finishing frame, for vertical or horizontal installation, without switch and socket.
Espejo 30x100 con marco acabado aluminio para la instalación vertical y horizontal. Sin interruptor y clema.



5447

Miscelatore monocomando per vasca incasso; con deviatore e bocca, con flessibile, doccetta, gancio di supporto e curva da incasso per presa acqua.

Built-in single lever bath mixer with diverter, wall mounted spout, with flexible hose, with hand shower, wall support and wall elbow connection.

Monomando para bañera de empotrar con desviador, ducha cilíndrica, con flexo, soporte a pared y curva de incastre para toma de agua.

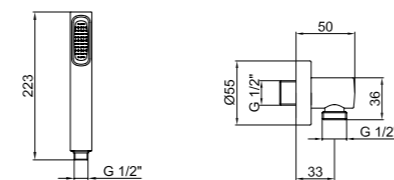
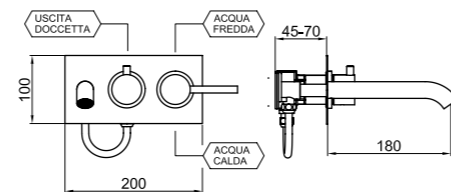

5443

Miscelatore monocomando per lavabo alto senza scarico; flex inox cm 70 att. 3/8" F.

High single lever washbasin mixer without pop-up waste, and 3/8" F flex. hoses cm70.

Monomando para lavabo alto, sin desagüe, con latiguillo de 70 cm, empalme 3/8" H.

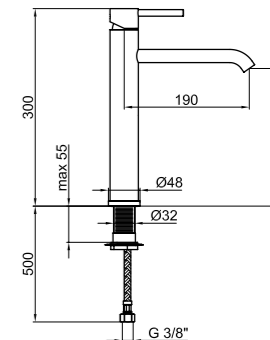

5444

Miscelatore monocomando per bidet con scarico 1"1/4 con flex inox cm 50 att. 3/8" F.

Single lever bidet mixer with 1"1/4 pop-up waste and 3/8" F flex. hoses cm 50.

Monomando para bidé con desagüe 1" 1/4, latiguillo de 50 cm, 3/8" H.

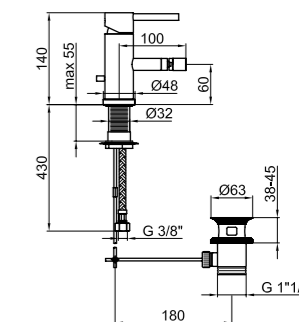

5449

Miscelatore monocomando free standing per vasca. H80.

Free standing single lever bathtub mixer. H80.

Monomando para bañera free standing. H80.



5445

Miscelatore monocomando per lavabo con scarico 1"1/4 con flex inox cm 50 att. 3/8" F.

Single lever washbasin mixer with 1"1/4 pop-up waste and 3/8" f. flex. hose 50cms

Monomando para lavabo con desagüe 1" 1/4, latiguillo de 50 cm, 3/8" H.

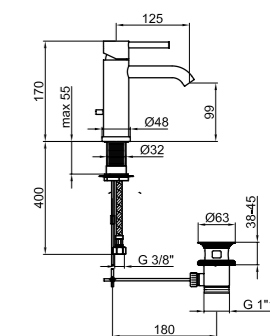

5442

Miscelatore monocomando free standing per lavabo. H105.

Free standing single lever basin mixer. H105.

Monomando para lavabo free standing. H105.

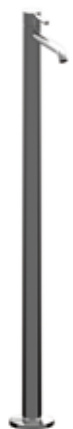

5446

Miscelatore monocomando per lavabo incasso muro, con piastra orizzontale, con scarico.

Concealed single lever washbasin mixer, horizontal cover plate, with pop-up waste.

Monomando empotrable de pared, con placa horizontal, con válvula de desagüe.

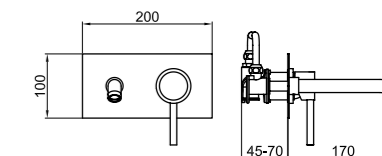



5423 Portarotolo in ceramica, 21x31cm.
Ceramic toilet roll-holder, 21x31cms.
Portarollos en cerámica, 21x31cm.

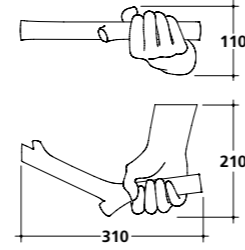

5427 Portascopino in ceramica, 9xh37cm.
Ceramic toilet brush-holder, 9xh37cms.
Escobilla en cerámica, 9xh37cm.

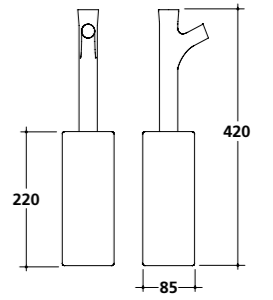

5424 Portasapone per lavabo e bidet, 24x11cm.
Ceramic soap dish for basin and bidet, 24x11cms.
Jabonera para lavabo y bidet, 24x11cm.

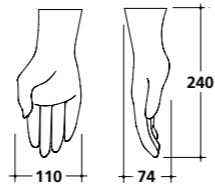

5428 Lampada in ceramica, 21x11cm.
Ceramic lamp, 21x11cms.
Aplique en cerámica, 21x11cm.

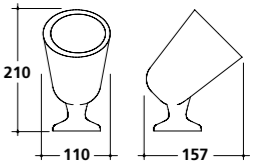

5425 Portasciugamani in ceramica, 14x53cm.
Installazione a parete.
Ceramic towel rack. Wall installation, 14x53cms..
Toallero en cerámica. Instalación a pared, 14x53cm.

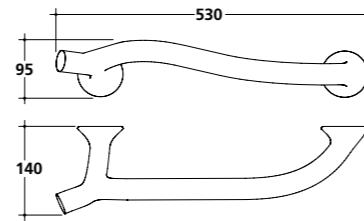

5426 Appendiabito in ceramica, 9x12cm.
Installazione a parete.
Ceramic hook. Wall installation, 9x12cms.
Percha en cerámica. Instalación a pared, 9x12cm.

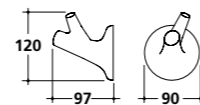

Galassia Spa persegue la filosofia di migliorare i prodotti aggiungendo nuovi materiali, innovazioni progettuali e tecnologie produttive. E' quindi possibile che i prodotti presentino caratteristiche e dimensioni diverse, migliorative rispetto a quelle illustrate in questo catalogo. Tali variazioni possono avvenire senza alcun preavviso.

Galassia spa is constantly improving its products by adding new materials, new projects and modern production technologies. For this reason it is possible that, in the future, without notice, the dimensions or the features of the products might be subject to change and improvement respect to those shown in this catalogue.

Galassia Spa persigue con empeño una intensa actividad de perfeccionamiento de sus productos que se concreta con la introducción de materiales, proyectos innovativos y tecnologías productivas. Por tanto es posible que los productos presenten características técnicas y estéticas diferentes respecto a las ilustradas en este catalogo. Galassia podrá realizar las modificaciones que estime oportuno para mejorar los productos sin aviso previo.

MEG**11**

concept
A + design

styling
Katuscia Ragazzo
Vincenzo Amato

foto
Lorenzo Borgianni

stampa
Telligraf

